

MARLIN®

MODEL 1895™

AND

MODEL 336™

LEVER-ACTION RIFLES

INSTRUCTION MANUAL



READ THE INSTRUCTIONS AND WARNINGS IN THIS MANUAL CAREFULLY BEFORE USING THIS FIREARM

FOR SERVICE ON THIS MODEL PLEASE CALL: 336-949-5200 (See page 50)

This manual may not be reproduced in whole or in part without the express written permission of Sturm, Ruger & Co., Inc.

This instruction manual should always accompany this firearm and be transferred with it upon change of ownership, or when the firearm is loaned or presented to another person.

Marlin 

MARLINFIREARMS.COM

State-By-State Warnings

Certain states require by law that their own specified warning notices in larger-than-normal type be conspicuously included by the manufacturer, distributor or retailer with firearms sold in that state. Sturm, Ruger & Co., Inc. sells its products, including both Marlin- and Ruger-branded firearms, in compliance with applicable laws and regulations. Because our products may be sold in these states, we include the following:

California:

WARNING

"Firearms must be handled responsibly and securely stored to prevent access by children and other unauthorized users. California has strict laws pertaining to firearms, and you may be fined or imprisoned if you fail to comply with them. Visit the Web site of the California Attorney General at <https://oag.ca.gov/firearms> for information on firearm laws applicable to you and how you can comply.

Prevent child access by always keeping guns locked away and unloaded when not in use. If you keep a loaded firearm where a child obtains and improperly uses it, you may be fined or sent to prison.

If you or someone you know is contemplating suicide, please call the national suicide prevention lifeline at 1-800-273-TALK (8255)."

ADVERTENCIA

"Las armas de fuego deben manipularse de manera responsable y segura para evitar el acceso de niños y otros usuarios no autorizados. California tiene leyes estrictas relacionadas con armas de fuego, y usted puede ser multado o encarcelado si no las cumple. Visite el sitio web del Procurador General de California en <https://oag.ca.gov/firearms> para obtener información sobre las leyes de armas de fuego que le son aplicables y cómo puede cumplirlas.

A los niños los atraen las armas de fuego y las pueden hacer funcionar. Ellos pueden causarse lesiones graves y la muerte. Evite que los niños tengan acceso a las armas de fuego guardándolas siempre con llave y descargadas cuando no las esté utilizando. Si usted tiene un arma de fuego cargada en un lugar en que un niño tiene acceso a ella y la usa indebidamente, le pueden dar una multa o enviarlo a la cárcel.

Si usted o alguien que conoce está pensando en suicidarse, llame a la línea nacional de prevención del suicidio al 1-800-273-TALK (8255)."

Connecticut:

"UNLAWFUL STORAGE OF A LOADED FIREARM MAY RESULT IN IMPRISONMENT OR FINE."

Florida:

"IT IS UNLAWFUL, AND PUNISHABLE BY IMPRISONMENT AND FINE, FOR ANY ADULT TO STORE OR LEAVE A FIREARM IN ANY PLACE WITHIN THE REACH OR EASY ACCESS OF A MINOR UNDER 18 YEARS OF AGE OR TO KNOWINGLY SELL OR OTHERWISE TRANSFER OWNERSHIP OR POSSESSION OF A FIREARM TO A MINOR OR A PERSON OF UNSOUND MIND."

Maine:

"ENDANGERING THE WELFARE OF A CHILD IS A CRIME. IF YOU LEAVE A FIREARM AND AMMUNITION WITHIN EASY ACCESS OF A CHILD, YOU MAY BE SUBJECT TO FINE, IMPRISONMENT OR BOTH. KEEP FIREARMS AND AMMUNITION SEPARATE. KEEP FIREARMS AND AMMUNITION LOCKED UP. USE TRIGGER LOCKS."

Maryland:

"WARNING: Children can operate firearms which may cause death or serious injury. It is a crime to store or leave a loaded firearm in any location where an individual knew or should have known that an unsupervised minor would gain access to the firearm. Store your firearm responsibly!"

Massachusetts:

"IT IS UNLAWFUL TO STORE OR KEEP A FIREARM, RIFLE, SHOTGUN OR MACHINE GUN IN ANY PLACE UNLESS THAT WEAPON IS EQUIPPED WITH A TAMPER-RESISTANT SAFETY DEVICE OR IS STORED OR KEPT IN A SECURELY LOCKED CONTAINER."

New Jersey:

"IT IS A CRIMINAL OFFENSE TO LEAVE A LOADED FIREARM WITHIN EASY ACCESS OF A MINOR."

New York:

"THE USE OF A LOCKING DEVICE OR SAFETY LOCK IS ONLY ONE ASPECT OF RESPONSIBLE FIREARM STORAGE. FOR INCREASED SAFETY, FIREARMS SHOULD BE STORED UNLOADED AND LOCKED IN A LOCATION THAT IS BOTH SEPARATE FROM THEIR AMMUNITION AND INACCESSIBLE TO CHILDREN AND UNAUTHORIZED PERSONS."

North Carolina:

"IT IS UNLAWFUL TO STORE OR LEAVE A FIREARM THAT CAN BE DISCHARGED IN A MANNER THAT A REASONABLE PERSON SHOULD KNOW IS ACCESSIBLE TO A MINOR."

Texas:

"IT IS UNLAWFUL TO STORE, TRANSPORT, OR ABANDON AN UNSECURED FIREARM IN A PLACE WHERE CHILDREN ARE LIKELY TO BE AND CAN OBTAIN ACCESS TO THE FIREARM."

Wisconsin:

"IF YOU LEAVE A LOADED FIREARM WITHIN THE REACH OR EASY ACCESS OF A CHILD YOU MAY BE FINED OR IMPRISONED OR BOTH IF THE CHILD IMPROPERLY DISCHARGES, POSSESSES, OR EXHIBITS THE FIREARM."

* * * * *

Please check with your licensed retailer or state police for additional warnings which may be required by local law or regulation. Such regulations change constantly, and local authorities are in the best position to advise you on such legal matters.

FIREARMS SAFETY IS YOUR RESPONSIBILITY
SAFETY MUST BE THE FIRST AND CONSTANT
CONSIDERATION OF EVERY PERSON WHO
HANDLES FIREARMS AND AMMUNITION.

Congratulations on the acquisition of your Marlin® centerfire lever-action rifle. As you may know, Marlin® firearms was acquired by Ruger in 2020. This manual applies only to Marlin® firearms manufactured by Ruger. This is easily determined by the location of manufacture – “Mayodan, NC” – which appears on the right side of the barrel.

This instruction manual is designed to assist you in learning how to properly use and care for your Marlin® rifle. Please contact us if you have any questions.

Only when you are certain you fully understand the manual and can properly carry out its instructions should you practice loading, unloading, etc. with live ammunition. If you have any doubts about your ability to handle or use a particular type of firearm safely, you should seek supervised instruction. Such personalized instruction often is available from local firearm retailers, gun clubs or police departments. If none of these sources can help, visit nra.org or write to the following address:

National Rifle Association
11250 Waples Mill Road
Fairfax, VA 22030-7400

The person possessing a firearm has a full-time job. You cannot guess; you cannot forget. You must know how to use your firearm safely. **Do not use any firearm without having a complete understanding of its particular characteristics and safe use.** Remember: There is no such thing as a foolproof firearm.

TABLE OF CONTENTS

State-By-State Warnings	3
Nomenclature	8
Locking Device Installation Instructions	9
General Information and Mechanical Characteristics	11
Operation of Hammer	12
Operation of Safety	14
Offset Hammer Spur	16
Lever and Bolt Assembly	17
Trigger Assembly	18
Ammunition	18
Getting Ready to Shoot	20
To Load and Fire	21
To Unload Rifle	26
To Extract and Eject a Chambered Cartridge	27
To Clear a Malfunction ("Jam" or "Misfire")	28
To Minimize Malfunctions ("Jams" or "Misfires")	30
Disassembly	31
Care and Cleaning	35
Maintenance of Stainless Steel Rifles	39
Reassembly	40
Check Your Rifle's Function	43
Sight Adjustment	47 - 48
Threaded Barrel (On Models So Equipped)	49
Storage	50
Service and Parts Policy	50
Shipping Firearms for Repair	51
Ordering Parts	52
Parts List	53
Exploded View	54
The Basic Rules of Safe Firearms Handling	55
Warranty Information	60



WARNINGS OF GREAT IMPORTANCE ARE FOUND ON THE FOLLOWING PAGES:

Locking Devices	9	Firing	24
Alterations	11	Handling	25
Hammer Down on Live Round	12	Malfunctions	28
Manual Safety	15	Disassembly	31
Ammunition	18	Lubrication	36
Ammunition Size	19	Storage	50
Lead Exposure	20	Shipping	51
Loading	21	Parts Purchasers	52

OTHER CAUTIONS AND WARNINGS APPEAR THROUGHOUT THE MANUAL.

NOMENCLATURE

These pictures show the main parts of a Marlin® rifle. The pictures will aid in understanding these instructions.

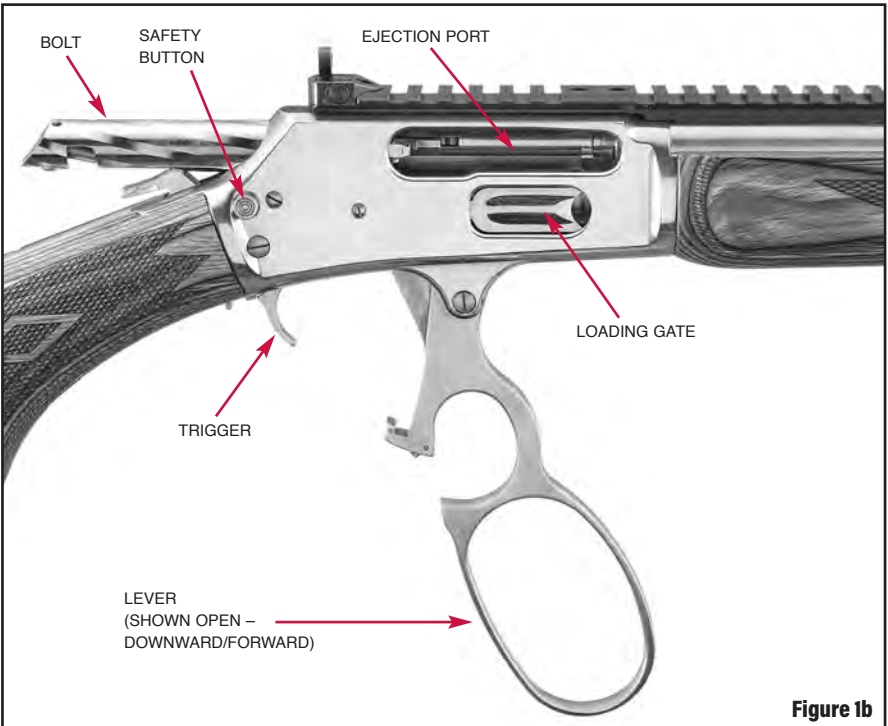
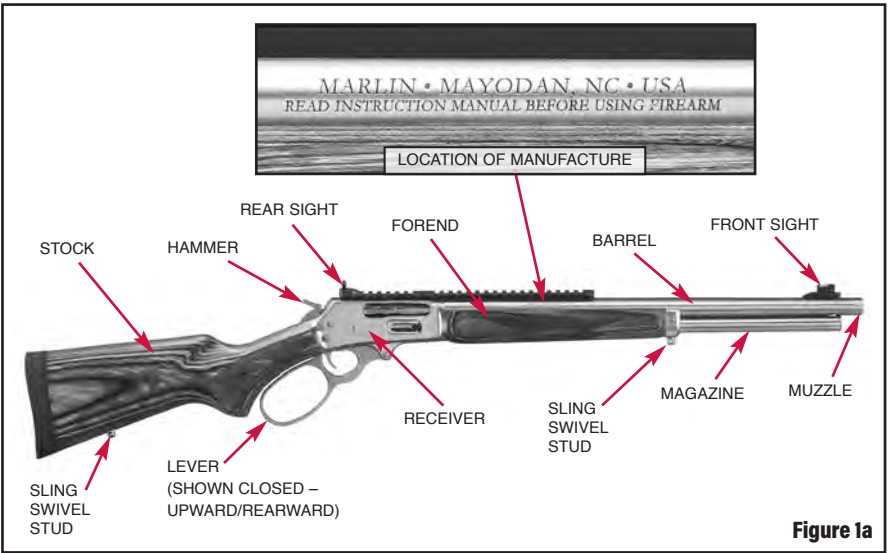

LOCKING DEVICE INSTALLATION INSTRUCTIONS



WARNING - USE OF LOCKING DEVICES



**Do not store
keys in lock.**

- Always keep your firearm pointed in a safe direction, including when you are installing or removing your locking device.
- Always verify that your firearm is completely unloaded before installing your locking device.
- Do not install locking devices in the trigger guard; always keep your fingers and locking device outside the trigger guard during device installation and removal.
- Store firearms, ammunition and keys separately and securely, away from children and careless adults; do not store your firearm with the keys in the locking device.
- Do not attempt to work the action of your firearm with the locking device in place; this may damage your firearm.
- While locking devices are an important aid to security measures, they are not a substitute for safe firearm handling or proper storage. Remember that any mechanical device can be bypassed with enough time, knowledge, determination and equipment.

**LOCKING DEVICES MUST BE USED
SAFELY AND RESPONSIBLY**

It is important to use the locking device on your Marlin® firearm when the firearm is stored or immediate use is not planned.

To Install the Factory-Supplied Locking Device:

1. Place the safety button in the "SAFE" position. See page 14.
2. **Be sure the firearm is completely unloaded and contains no cartridges or cartridge cases! See p. 26.**
3. Open the action completely by moving the lever to its downward/forward position. Keep the action open during installation of the locking device.

4. Remove the lock from the cable using the key supplied with the lock.
5. Insert the portion of the cable that fits into the lock body into the rifle's ejection port and feed it down the bore until it protrudes from the muzzle. See Figure 2.
6. To lock: With the key turned to the farthest clockwise position, insert the loose end of the cable into the lock. Turn the key counterclockwise and remove the key.
7. Once the lock is securely closed, pull firmly on the lock to test the connection and be sure it is locked. **Do not leave or store your firearm with the key in the lock!** Store your locked, unloaded firearm and the key in secure, separate locations, away from ammunition, children, and unauthorized adults.

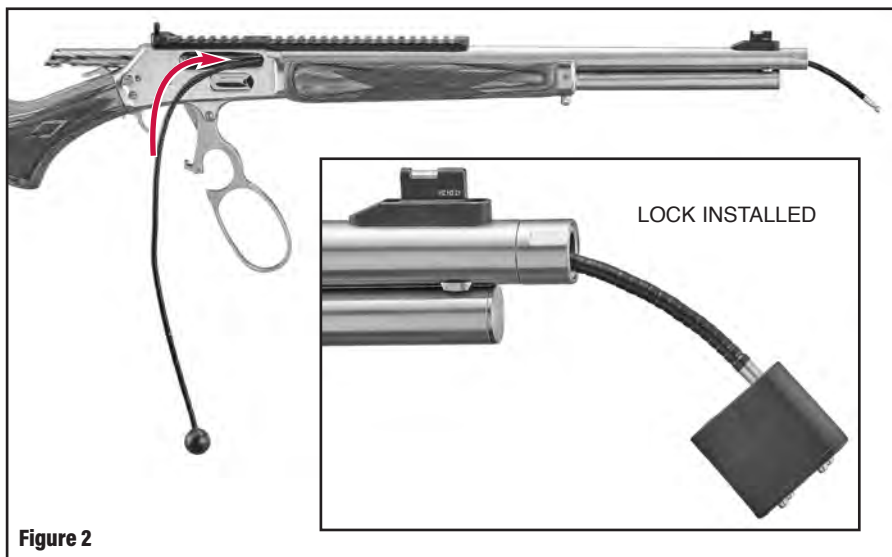

Figure 2

Correct installation of the lock on a Marlin® rifle.

FIREARMS ARE DANGEROUS WEAPONS.

**READ THE INSTRUCTIONS AND WARNINGS IN THIS
MANUAL THOROUGHLY AND CAREFULLY BEFORE USING.**

 WARNING - ALTERATIONS	
	<p>This product was designed to function properly in its original condition. Alterations can make it unsafe. Do not alter any part or add or substitute parts or accessories not made or sold by Sturm, Ruger & Co., Inc.</p> <p>Aftermarket parts or OEM parts manufactured prior to the acquisition of Marlin® by Sturm, Ruger & Co., Inc. may not work or fit correctly; do not use them.</p>
DO NOT ALTER ANY FIREARM	

GENERAL INFORMATION AND MECHANICAL CHARACTERISTICS

Your Marlin® rifle is capable of firing multiple shots by cycling the action and pulling the trigger. Assuming the user is planning to fire the rifle immediately, the cycling sequence should start with the lever in the upward/rearward position, the bolt closed, the chamber empty, the safety in the "SAFE" position (see p. 14), and no rounds in the magazine. Rotating the lever downward/forward retracts the bolt, disengages the trigger and disconnects the firing pins. As the bolt moves rearward, any cartridge in the chamber is extracted from the chamber and ejected from the firearm. A new cartridge is released from the magazine (assuming a round has been loaded into the magazine, see p. 23) onto the carrier and the hammer is cocked as the lever completes its rotation downward/forward. Rotating the lever upward/rearward lifts the carrier, allowing the new cartridge to be loaded into the chamber as the bolt is closing. The cycle sequence is completed when the lever is fully rotated upward/rearward, locking the bolt forward, engaging the trigger and aligning the firing pins. Manually moving the safety mechanism to the "FIRE" position and pulling the trigger will discharge the rifle. Additional rounds can be loaded and fired by cycling the action using the lever and pulling the trigger.

Serial Number and Cartridge Designation:

The serial number of your firearm is located on the shooter's left side of the receiver.

Use only the specified cartridge type and caliber of ammunition designated on the barrel. See "To Load and Fire," p. 21. See Figures 3a and 3b.

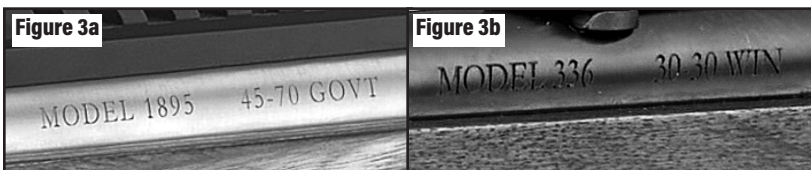

Safety Features:

In addition to the manual safety mechanism and traditional hammer half cock, Marlin® centerfire lever-action firearms incorporate passive features that provide additional protection against accidental or unintentional discharge under normal usage and when the firearm is kept in good working order. These passive features include: the two-piece firing pin system; steel alloys and/or their metallurgical treatments; the sear, trigger, and hammer engagements; the lock-up system; headspace; trigger block; and the lever. These devices are mostly passive and work without direct input from the user, provided your firearm is kept clean and in good working order.

Do not alter, modify, bypass, or render these safety features inoperative.

OPERATION OF HAMMER

Your Marlin® rifle has an exposed hammer with three (3) positions:

FULL FORWARD - the hammer is fully forward, resting on the firing pin. See Figure 4a, p. 13.



WARNING – HAMMER DOWN ON A LIVE ROUND

If the hammer is placed in the full forward position and there is a live round in the chamber with the manual safety in the disengaged ("FIRE") position, a sharp blow to the hammer may cause the rifle to discharge.

Should the hammer inadvertently be placed in the full forward position, open the bolt, move the safety button to the "SAFE" position, and close the bolt. The hammer is now in the full cock position and the safety engaged. In this condition, you can safely lower the hammer to the half cock position. Follow the instructions on p. 13 to move the hammer to the half cock position.

NEVER PLACE THE HAMMER IN THE FULL FORWARD POSITION OVER A LIVE ROUND!

HALF COCK - the hammer is located rearward at the first stageable position. Traditionally, this position is referred to as the "half cock safety."

NOTE: A sharp blow to the hammer while in the half cock notch can damage or break internal parts, which may cause the hammer to strike the firing pin. **Always keep the safety mechanism in the "SAFE" position when the hammer is being carried in the half cock position.**

To Move the Hammer to the Half Cock Position:

First, put the safety mechanism (see p. 14) on "SAFE" so that the hammer is blocked and cannot contact the firing pin. The hammer may be moved from full cock to the half cock position by firmly holding the hammer in the full cock position with your thumb. Keep your thumb on the hammer as you pull the trigger. As soon as you feel the hammer exerting forward pressure on your thumb, remove your finger from the trigger and then ease the hammer slowly forward to the half cock position (See Figure 4b, below). The hammer is now in the half cock position.

FULL COCK - the hammer is located fully rearward at the second stageable position. See Figure 4c.

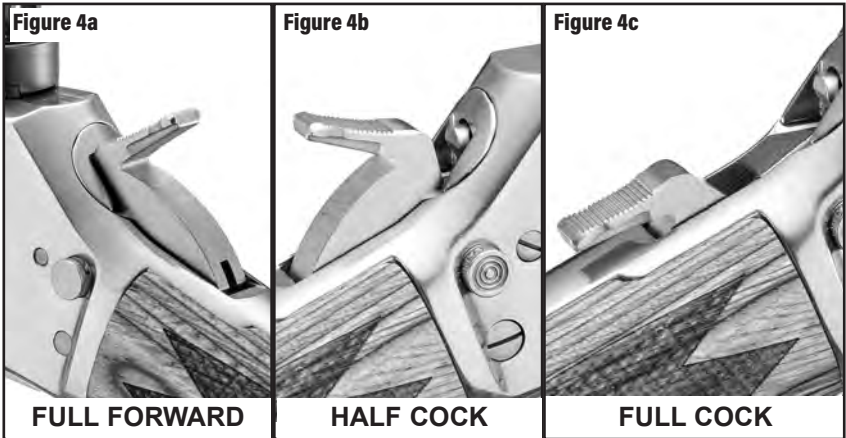

WARNING - DECOCKING THE RIFLE

Lowering the hammer from the full cock to another position (decocking) should not be attempted unless the safety mechanism is engaged. Always keep the firearm pointed in a safe direction when decocking the rifle.

Should the hammer inadvertently be placed in the full forward position, rotate the lever downward/forward to open the bolt, engage the safety mechanism by moving it to the "SAFE" position (red band no longer visible), then close the bolt using the lever. The hammer is now in the full cock position and the safety engaged. In this condition, you can safely lower the hammer to the half cock position. Follow the instructions above to move the hammer to the half cock position.

ONLY DECOCK THE RIFLE WITH THE SAFETY ENGAGED!

OPERATION OF SAFETY

The manual safety mechanism of your Marlin® rifle is a hammer-block type, providing protection against accidental or unintentional discharge under normal usage when properly engaged and in good working order. The safety mechanism blocks the hammer, preventing the hammer from striking the firing pin when fully engaged in the "SAFE" position. This safety mechanism is not a substitute for following the rules of safe firearm handling.

The safety mechanism is located towards the rear of the receiver, above the trigger. To engage the safety mechanism, push the safety button fully to the shooter's right until the safety button stops. See Figure 5. The red band will not be visible with the safety engaged or in the "ON" position.

NOTE: The safety button can only be moved if the hammer is in the half cock or full cock position. The safety button cannot be moved if the hammer is in the full forward position.

Always engage the safety mechanism by moving the safety button fully to the shooter's right before handling, loading or unloading the firearm.

When you are ready to discharge the firearm, disengage the safety mechanism by pushing the safety button to the shooter's left. This is the "FIRE" position. The safety button's red band will be visible. See Figure 6. You have now disengaged the safety mechanism. If the hammer is fully cocked and the lever is fully closed, the firearm is ready to fire.

When the safety mechanism is in the "FIRE" position, it is referred to as being "OFF." When the safety mechanism is in the "SAFE" position, it is referred to as being "ON."



Figure 5 Safety button in "SAFE" (to the right - red band not visible) position. **Keep the safety mechanism in this position except when actually firing.**



Figure 6 Safety button in "FIRE" (to the left - red band visible) position. The safety mechanism should be moved to this position only when the firearm user is actually firing the rifle.

Do not touch the trigger while moving the safety mechanism. Your fingers and all other objects should be kept outside of the trigger guard and away from the trigger until you are actually ready to fire your rifle.

Unless you are decocking the rifle, never attempt to pull the trigger when the safety mechanism is activated in the "SAFE" position.

Even when the safety is engaged in the "SAFE" position, careless handling can cause the firearm to discharge. See "The Basic Rules of Safe Firearms Handling," p. 55.



WARNING - MANUAL SAFETY

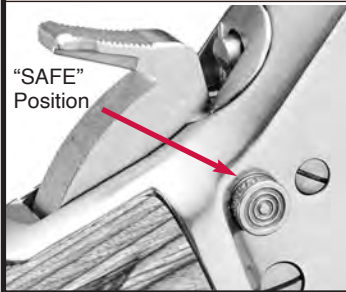

"SAFE"
Position

Keep the safety button in the "SAFE" position unless actually firing. Always move the safety fully to its intended position and check it. The safety has two positions - "SAFE" and "FIRE." Never depend on a safety mechanism or any other mechanical device to justify careless handling or pointing the rifle in an unsafe direction. The only "safe" rifle is one in which the bolt is open and the chamber and magazine are empty.

KNOW HOW TO USE THE SAFETY

OFFSET HAMMER SPUR

The offset hammer spur and a mounting wrench are provided to ensure the best hammer control possible when a scope is mounted on the receiver of your rifle. This is because, depending on the scope, there may not be enough space between the scope and the hammer to adequately place a thumb on the hammer and control it.

Caution: Always use an offset hammer spur when a scope is mounted on the receiver of your Marlin® rifle.

NOTE: The offset hammer spur can be mounted on either side of the hammer to accommodate left- or right-handed shooters.



WARNING - USE OF SCOPES

Do not use the rifle with a scope unless the Marlin® offset hammer spur is securely attached in the proper position. Make periodic checks to ensure the offset hammer spur is securely attached to the hammer.

USE THE OFFSET HAMMER SPUR WITH SCOPES

To Mount a Hammer Spur:

1. **Always keep the firearm pointed in a safe direction.**
2. Open the action by rotating the lever downward/forward until the bolt is fully rearward.
3. Engage the safety mechanism by moving the safety button fully to the shooter's right. The red band will not be visible.
4. Look into the ejection port, visually check the chamber, loading port and magazine for cartridges, ensuring the firearm is completely unloaded. If the firearm is not empty, see "To Unload Rifle," p. 26.
5. Make sure the barrel is free of obstructions, see "To Check the Barrel for Obstructions," p. 28.
6. Secure the offset hammer spur to the hammer by inserting and tightening the set screw with the hex wrench provided in packaging. See Figure 7. The offset hammer spur may be mounted on either the right or left side of the hammer.

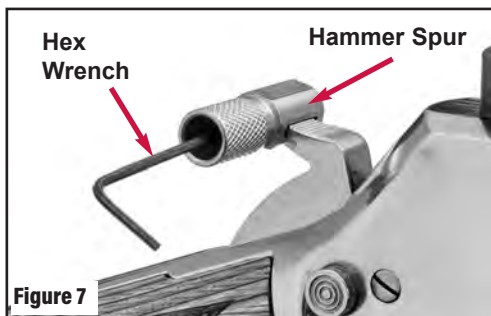

LEVER and BOLT ASSEMBLY

The lever is used to open and close the action (bolt assembly) and is the interface to un-block the trigger and engage the locking bolt when fully rotated rearward in the closed position. See Figure 8. The bolt is opened by rotating the lever downward/forward.



When the locking bolt is fully engaged in the bolt assembly, it aligns the front and rear firing pins and pushes the bolt assembly against the breech. This locks the cartridge into the chamber and contains the discharged pressure of the ammunition within the chamber during firing. The bolt assembly is a one-piece system (see Figure 9), manufactured specifically for your firearm to maintain proper headspace (distance between the cartridge seat and the bolt face). Bolt assemblies are not interchangeable between rifles. For your safety, keep your bolt assembly paired with its respective rifle.

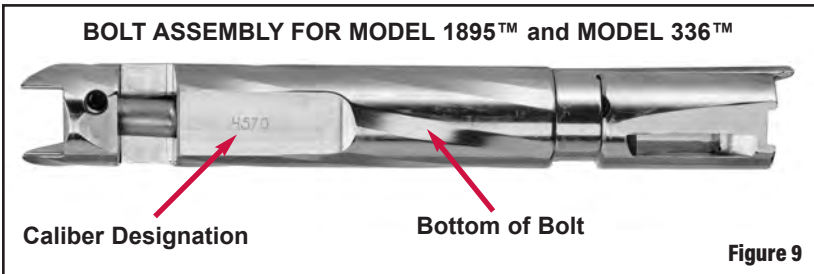

WARNING - BOLT ASSEMBLIES ARE NOT INTERCHANGEABLE

Use only the original bolt within your firearm. Damage to the firearm, serious personal injury and/or death may result from an improperly matched bolt and receiver combination.

NEVER SWAP BOLT ASSEMBLIES BETWEEN RIFLES!

TRIGGER ASSEMBLY

Marlin® lever-action centerfire firearms are equipped with Marlin's custom designed trigger assembly. The trigger assembly is a single-action system that has been designed for optimal trigger pull weight. The trigger assembly provides a crisp, clean trigger pull for superior out-of-the-box accuracy. The trigger assembly is not adjustable. All repairs should be performed at the factory. See "Shipping Firearms for Repairs," p. 51.

Never place your finger on the trigger unless the safety mechanism is engaged or you are ready to discharge the firearm.



WARNING – MODIFICATIONS OR ADJUSTMENTS

Never manipulate, adjust or change any of the internal components in your firearm unless specifically directed to do so in this instruction manual. Improper manipulation of any internal component may affect the safety and reliability of your firearm and may cause serious injury or death.

AMMUNITION

Marlin® rifles are chambered for factory-loaded cartridges manufactured in accordance with U.S. industry practice. The particular caliber for each rifle is marked on the barrel. Use only factory ammunition in good condition that exactly matches the caliber of your rifle as designated on the barrel. **We do not recommend the use of +P ammunition.**



WARNING – AMMUNITION



Use only new, factory ammunition of the correct caliber.

Death, serious injury, and damage can result from the wrong ammunition, bore obstructions, powder overloads or incorrect cartridge components.

Always wear shooting glasses and hearing protection.



IMPROPER AMMUNITION DESTROYS FIREARMS

AMMUNITION (CARTRIDGES) NOTICE

WE SPECIFICALLY DISCLAIM RESPONSIBILITY FOR ANY DAMAGE OR INJURY WHATSOEVER OCCURRING IN CONNECTION WITH, OR AS A RESULT OF, THE USE IN ANY MARLIN FIREARMS OF FAULTY, OR NON-STANDARD, OR "REMANUFACTURED" OR HAND-LOADED (RELOADED) AMMUNITION, OR OF CARTRIDGES OTHER THAN THOSE FOR WHICH THE FIREARM WAS ORIGINALLY CHAMBERED.

Ammunition Notes and Warnings:

NOTE: If your rifle is chambered for 45-70 Gov't. or 30-30 Win, please carefully review the following warning and dimensions.

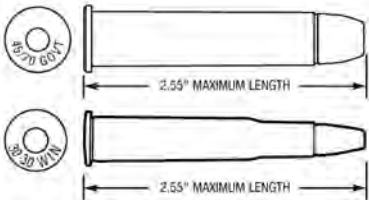
 WARNING - AMMUNITION SIZE	
	The cartridges shown, indicate Industry Standard 45-70 Gov't and 30-30 Win dimensions. Use of ammunition that does not comply with these dimensions could cause personal injury and damage to the rifle.
BE SURE DIMENSIONS OF AMMUNITION ARE CORRECT	

NOTE: For the Model 1895™, Hornady LEVERevolution Ammunition, (with red, flexible bullet tip: 45-70 Gov't 2.60" maximum length) may be used. Hard pointed bullets should not be used.

NOTE: For the Model 336™, Hornady LEVERevolution Ammunition, (with red, flexible bullet tip: 30-30 Win maximum length 2.60") may be used. Hard pointed bullets should not be used.

NOTE: Marlin® does not recommend using aluminum-cased ammunition in Marlin® lever-action firearms. These cartridges are not compatible with the lever-action's feeding system and may inadvertently remain in the magazine.

NOTE: Do not apply oil, grease or any lubricants to cartridges. This may cause your action and/or magazine to become fouled, which, in turn, can adversely affect the safety and reliability of your firearm.

Always wash your hands after handling ammunition.

 WARNING- POINTED AMMUNITION	
Some pointed and full metal jacket round nose bullets can "chain-fire" other cartridges in a tubular magazine during recoil, causing damage to firearm and potentially serious injury or death. All soft nose bullets, including flexible tip bullets specifically designed for use in tubular magazine systems, can be used safely in Marlin lever-action firearms. Hard pointed bullets should not be used. If you are uncertain about the safety of using a particular cartridge in your Marlin firearm, contact Marlin® customer service. See p. 50.	



WARNING - LEAD EXPOSURE

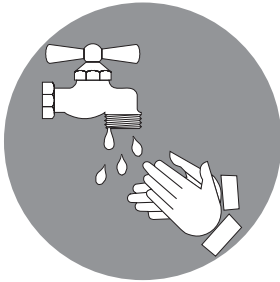

Discharging firearms in poorly ventilated areas, cleaning firearms, or handling ammunition may result in exposure to lead and other substances known to the State of California to cause birth defects, reproductive harm, and other serious physical injury. Have adequate ventilation at all times. Wash hands thoroughly after exposure.

**SHOOTING OR CLEANING FIREARMS
MAY EXPOSE YOU TO LEAD**

GETTING READY TO SHOOT

When preparing to use your rifle, it is prudent to check it carefully and ensure it is in good working order, as follows:

1. **Always keep the firearm pointed in a safe direction.**
2. Open the action by rotating the lever downward/forward until the bolt is fully rearward.
3. Engage the safety mechanism by moving the safety button fully to the shooter's right. The red band will not be visible.
4. Look into the ejection port and visually check the chamber, loading port, and magazine for cartridges and ensure the firearm is completely unloaded.
5. Look into the ejection port, ensure the firing pin tip is NOT protruding from the bolt face. Figure 10 shows the correct firing pin tip position (not protruding).

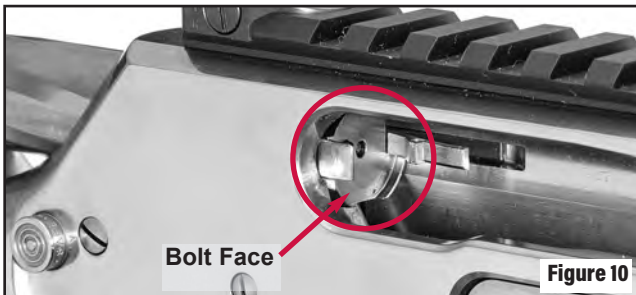



WARNING - PROTRUDING FIRING PIN

If the firing pin is protruding from the bolt face, your firearm is not safe. Contact Marlin® customer service to arrange for return and repair of the rifle. See "Shipping Firearms for Repairs," p. 51. The use of a firearm that is not in a safe operating condition may result in serious personal injury, injury to by-standers and/or death and damage to property.

6. Close the bolt by rotating the lever fully upward/rearward.
7. With the safety mechanism engaged, place your thumb on the hammer and apply enough thumb pressure to keep the hammer from moving when it is released.
8. While maintaining control of the hammer, pull the trigger until the trigger releases, allow the hammer to partially move forward, remove your finger from the trigger, and lower the hammer to the first stageable position or the half cock position. See the "Half Cock" Figure 4b on p. 13.

NOTE: Marlin® recommends practicing moving the hammer from full cock to the half cock position with an unloaded firearm until you are confident you can uncock the firearm without losing control of the hammer.

TO LOAD AND FIRE

 <h3 style="margin: 0;">WARNING - LOADING</h3>	
	<p>Know the caliber of the rifle you are loading and load cartridges of only that caliber into it! The wrong ammunition can destroy your firearm and result in serious injury.</p> <p>If a cartridge does not chamber readily, do not force it. Check the bore and chamber to be certain that each cartridge is the proper caliber and of correct dimensions. If you cannot determine why the cartridge will not fit, clear the rifle of all cartridges and write or call the factory.</p>
	<p>LOAD ONLY THE CORRECT AMMUNITION IN GOOD CONDITION</p>

Caution: The bore should be cleaned before loading the firearm the first time. Follow the cleaning instructions shown on p. 36, "To Clean the Barrel." Before loading the firearm, always make sure the inside of the barrel is free of dirt, oil, or other obstructions. See "To Check the Barrel for Obstructions," p. 28.

Lever-action centerfire firearms are manufactured in different centerfire calibers. The specific caliber of centerfire ammunition suitable for use in your firearm is marked on the barrel of your firearm. Use only the specific caliber of centerfire ammunition designated on the barrel of your firearm. Different calibers of centerfire ammunition are not interchangeable. Do not use any ammunition other than what is designated for your firearm. Using incorrect ammunition in your firearm can result in a severe malfunction of your firearm and/or ammunition leading to personal injury or death. See "Warning - Ammunition," on p. 18.

Do not load the rifle until you are ready to use it!

To Load the Firearm:

Before loading your rifle, always check and verify that the cartridge you are loading is the correct designation (caliber).

The use of improperly reloaded or hand-loaded ammunition can lead to barrel obstructions, excessive pressure and/or inadvertent discharge of a firearm, resulting in property damage, personal injury and/or death. See "Warning - Ammunition," on p. 18.

1. **Always keep the firearm pointed in a safe direction.**
2. Open the action by rotating the lever downward/forward until the bolt is fully rearward.
3. Engage the safety mechanism by moving the safety button fully to the shooter's right. The red band will not be visible.
4. Look into the ejection port, visually check the chamber, loading port and magazine for cartridges, ensuring the firearm is completely unloaded.

To Load a Single Round Into the Chamber:

5. With an empty magazine, place one cartridge of the correct caliber through the ejection port onto the carrier with the bullet pointed toward the muzzle. See Figure 11.

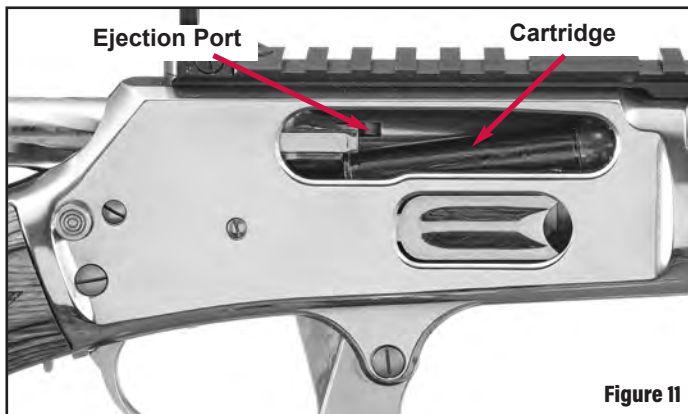

6. Close the bolt by rotating the lever fully upward/rearward, locking the cartridge in the chamber.

NOTE: The firearm is now loaded with a cartridge in the chamber.

To Load the Magazine:

Before loading your rifle, always check and verify that the cartridge you are loading is the correct designation (caliber).

The use of improperly reloaded or hand-loaded ammunition can lead to barrel obstructions, excessive pressure and/or inadvertent discharge of a firearm, resulting in property damage, personal injury and/or death.

1. Always keep the firearm pointed in a safe direction.
2. Open the action by rotating the lever downward/forward until the bolt is fully rearward.
3. Engage the safety mechanism by moving the safety button fully to the shooter's right. The red band will not be visible.
4. Look into the ejection port, visually check the chamber, loading port and magazine for cartridges, ensuring the firearm is completely unloaded.
5. Make sure the barrel is free of obstructions. See "To Check the Barrel for Obstructions," p. 28.
6. With the chamber empty, close the bolt by rotating the lever fully rearward/upward.
7. Lower the hammer from the full cock position to the half cock position. See "Operation of the Hammer," p. 12.
8. Insert a cartridge, bullet end first, by pushing the loading gate with the nose of the cartridge. See Figure 12.
9. Push the cartridge forward into the magazine until it is captured behind the loading gate. See Figure 13.
10. Insert an additional cartridge, bullet end first, by pushing the loading gate with the nose of the cartridge.
11. With the nose of the additional cartridge, push the preceding cartridge deeper into the magazine, until the cartridges are captured behind the loading gate.
12. Repeat steps 9 and 10 until the magazine is full. Ensure the last cartridge is completely inside the magazine and forward of the loading gate. See Figure 13.

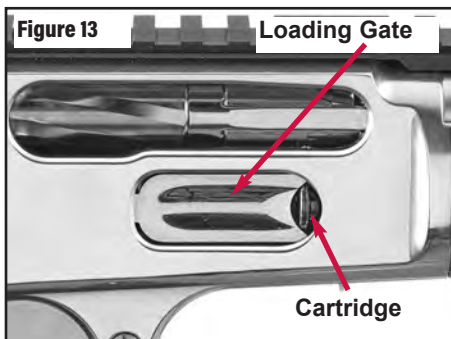
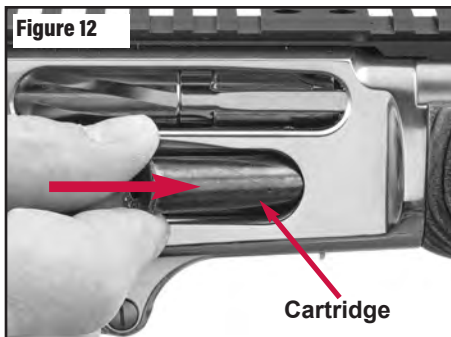

To Load the Chamber From the Magazine:

13. With a cartridge in the magazine, open the bolt by rotating the lever fully downward/forward.
14. Close the bolt by rotating the lever fully upward/rearward.

Both the chamber and magazine are loaded!

The firearm is now cocked and loaded. Make sure the safety mechanism is still engaged in the "SAFE" position. Always keep the firearm pointed in a safe direction.



WARNING: DO NOT TOUCH THE TRIGGER WITH THE SAFETY DISENGAGED UNTIL YOU ARE ACTUALLY READY TO FIRE THE RIFLE.



WARNING - FIRING



When firing the Marlin centerfire lever-action rifle, be sure that bystanders are well clear of the shooter and standing a safe distance to the rear. Empty cartridge cases are hot and are normally ejected from the rifle to the right. They could cause injury to any person who is standing too closely alongside the shooter. Shooters who fire rifles from their left shoulder should be particularly cautious concerning ejected cartridge cases.

EJECTED BRASS IS HOT

To Discharge the Firearm:

Always wear eye and hearing protection when discharging your firearm. See "The Basic Rules of Safe Firearms Handling," p. 55.

1. Point the muzzle at your intended target and carefully sight in the rifle using the iron sights (or optic, if so equipped).
2. Move the hammer to the full cock position with your thumb.
3. Disengage the safety mechanism by moving the safety button fully to the shooter's left to the "FIRE" position. The red band will be visible.
4. With the target acquired and the butt of the firearm mounted firmly against your shoulder, pull the trigger to fire the rifle.
5. To fire another round, cycle the action by first rotating the lever downward/forward and then upward/rearward. You can fire the rifle by pulling the trigger.

NOTE: If you do not fire all the cartridges in the magazine, be sure to put the hammer in the half cock position and the safety mechanism on "SAFE" until you are ready to shoot again.

6. Open the action by rotating the lever downward/forward until the bolt is fully rearward.
7. Engage the safety mechanism by moving the safety button fully to the shooter's right. The red band will not be visible.
8. Look into the ejection port and visually check the chamber, loading port and magazine for cartridges, ensuring the firearm is completely unloaded. If the firearm is not empty, see "To Unload Rifle," p. 26.
9. Make sure the barrel is free of obstructions, see "To Check the Barrel for Obstructions," p. 28.



WARNING - MISFIRES

If a cartridge does not discharge when the trigger is pulled (called a "misfire"), keep the firearm pointed in a safe direction and wait one minute before opening the bolt or the action. See "To Unload Rifle," p. 26.

If the "report" of the discharged cartridge is noticeably softer or louder or any way irregular, keep the firearm pointed in a safe direction, unload the firearm and check for bore obstructions and damage to your rifle. See "To Check the Barrel for Obstructions," p. 28.



WARNING - HANDLING



Remember that each time a cartridge is fired and a new one is chambered, the safety mechanism is in the "FIRE" position.

Therefore, if the rifle is not going to be discharged immediately after the cartridge is chambered, move the safety mechanism fully to the "SAFE" position.

Never carry the rifle loaded with the safety mechanism in the "FIRE" position. If dropped or struck with the safety off, the rifle may fire. Such a discharge can occur with or without the trigger being directly struck or touched.

Never rest a loaded rifle against any object (wall, fence, vehicle, tree, etc.) because there is always the possibility that the rifle will be jarred or slide from its position and fall with sufficient force to discharge. Keep the safety mechanism on unless you are actually firing the rifle.

**ANY FIREARM MAY FIRE
IF DROPPED**

TO UNLOAD RIFLE

UNLOAD THE RIFLE IMMEDIATELY WHEN YOU ARE FINISHED SHOOTING.

NEVER assume your firearm is unloaded to justify careless handling. Always control the direction of the muzzle of your firearm and keep it pointed in a safe direction, even if you think it is completely unloaded.

If you choose to discontinue shooting before all of the cartridges in the magazine and the chamber have been fired, proceed as follows (**Keep your fingers away from the trigger at all times during unloading**):

1. Open the action by rotating the lever downward/forward until the bolt is fully rearward. This will extract and eject a live cartridge or spent cartridge case in the chamber.
2. Engage the safety mechanism by moving the safety button fully to the shooter's right. The red band will not be visible.
3. Close the action by rotating the lever upward/rearward until the bolt is fully forward. This will chamber the next round from the magazine.
4. Repeat steps 1 through 3 until all cartridges are ejected from the firearm (both the magazine and the chamber.) See "Correct Unloading Sequence" below.
5. With the bolt open, look into the ejection port and visually check the chamber, loading port and magazine for cartridges, ensuring the firearm is completely unloaded.
6. Make sure the barrel is free of obstructions. See p. 28, "To Check the Barrel for Obstructions."

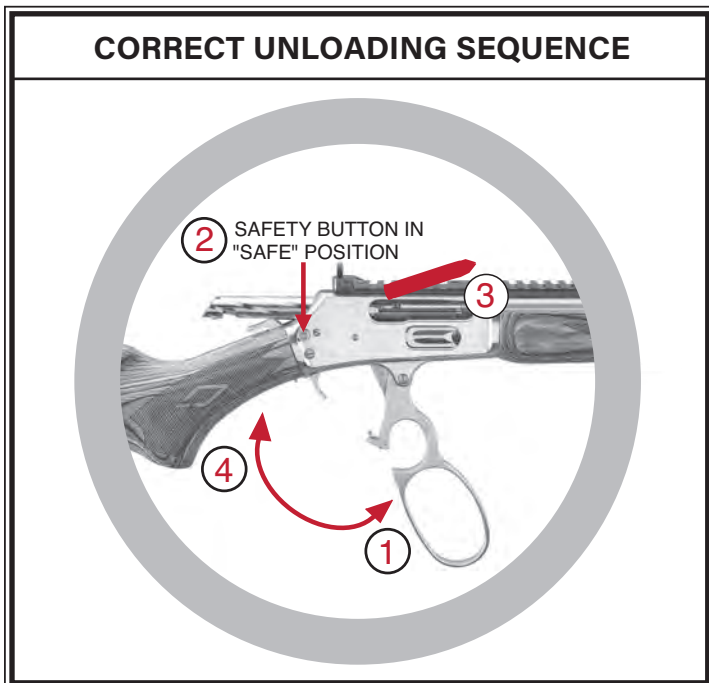

TO EXTRACT AND EJECT A CHAMBERED CARTRIDGE

When the bolt is operated using the lever, there can be a failure to extract the cartridge from the chamber, or a failure to eject the cartridge clear of the rifle. These failures usually are the result of the bolt not being cycled rearward vigorously enough via the lever, coupled with an accumulation of bullet lubricant in the chamber.

To avoid this type of failure, the firearm user must:

1. **Always visually check the chamber after opening the bolt to eject a chambered cartridge.** If the bolt is not vigorously retracted via the lever, the extracted cartridge can be "ejected" back onto the carrier, instead of outside the rifle.
2. Thoroughly clean the chamber and the extractor as often as necessary to prevent the accumulation of grease and dirt.
3. If the magazine is empty when the bolt is being retracted (via the lever) to extract a cartridge, the cartridge may drop on top of the carrier. Then, when the bolt moves forward, the cartridge will be chambered again!
Always make sure the magazine is empty before clearing the chamber, and visually ensure that no cartridges remain in the firearm.

TO CLEAR A MALFUNCTION ("JAM" or "MISFIRE")



WARNING - MALFUNCTIONS



NEVER try to remove an object from the barrel by loading another cartridge and firing. This may cause serious personal injury or death.

If a cartridge hangs up, jams, or binds when being chambered or when being fed from the magazine into the chamber, **do not attempt to force it into the chamber by pushing or striking the lever.**

Most failures of a cartridge to feed or to chamber are caused by improper loading of the magazine or ammunition that is incorrect or defective.

Whatever the cause, the user must, above all, recognize that jams can result in the potentially very dangerous situation of a cartridge discharging before it is chambered. If this occurs, the cartridge case will rupture and its fragments will fly out of the firearm with sufficient force to cause injury. Always wear shooting glasses and hearing protection!



STRIKING PRIMER CAN BURST CARTRIDGE

If a jam occurs, immediately put the safety button in the "SAFE" position and be certain the muzzle of the rifle is at all times pointing in a safe direction.

To Check the Barrel for Obstructions:

1. Again, keep the firearm pointed in a safe direction.
2. Open the action by rotating the lever downward/forward until the bolt is fully rearward.
3. Engage the safety mechanism by moving the safety button fully to the shooter's right. The red band will not be visible.
4. Look into the ejection port, visually check the chamber, loading port, and magazine to make sure the firearm is completely unloaded. If the firearm is not unloaded, see "To Unload Rifle," p. 26.

5. Insert a cleaning rod of the correct bore size into the muzzle.
6. Push the cleaning rod completely through the barrel until the rod can be seen at the ejection port.

To Remove a Bore Obstruction:

1. **Always keep the firearm pointed in a safe direction.**
2. Open the action by rotating the lever downward/forward until the bolt is fully rearward.
3. Engage the safety mechanism by moving the safety button fully to the shooter's right. The red band will not be visible.
4. Look into the ejection port and visually check the chamber, loading port, and magazine to make sure the firearm is completely unloaded. If the firearm is not unloaded, see "To Unload Rifle," p. 26.
5. Insert a cleaning rod of the correct bore size into the muzzle.
6. Lightly tap the cleaning rod against the obstruction to free the object from the barrel. Remove the object through the ejection port.
7. Push the rod completely through the barrel until the rod can be seen at the ejection port.
8. If an object cannot be easily pushed out of the barrel with a cleaning rod, return the firearm to the factory for service. See "Service and Parts Policy" on p. 50.

If the above procedures do not result in a smooth and reliable feeding firearm, do not use the rifle. The rifle can be returned directly to our Customer Service Department for inspection and repair, if required. See the "Service and Parts Policy" section of the manual for packing and shipping information on p. 50.

Examine your fired cartridge cases. If they have split, blown or bulged heads, stop using that ammunition and promptly return the rifle to the factory for examination.

TO MINIMIZE MALFUNCTIONS ("JAMS" or "MISFIRES")

Firearms of all makes and types are susceptible to occasional malfunctions due to a cartridge not feeding from the magazine to the chamber, or due to a cartridge or fired case not being extracted and ejected.

To minimize the possibility of such occurrences the firearm user should:

- Use ammunition of the correct caliber and type which is loaded to U.S. Industry Specifications. Do not use cartridges that are deformed or cartridges that have been reloaded.
- Clean and lubricate the firearm in accordance with the instructions in this manual.
- Learn to correctly operate the lever-action and how to properly load and empty the chamber and magazine.
- **If the mechanism shows signs of not functioning correctly, or if a part is damaged or broken – do not use the rifle. Have it inspected and repaired.**

For most repairs, we recommend that Marlin firearms be returned to the factory. However, if a firearm has a cartridge in it which cannot be removed, then it is a violation of Federal Regulations to ship that loaded firearm whether it be by U.S. Mail or by common carrier. In that case, contact our Customer Service Department at 336-949-5200 for assistance.



WARNING - DISASSEMBLY



Always unload a firearm before cleaning, lubrication, disassembly or assembly.

**UNLOAD BEFORE
CLEANING**

DISASSEMBLY

(Rifle Must Be Unloaded Prior To Disassembly)

Always wear eye protection when handling, disassembling and assembling the firearm.

It is preferable to carry out these procedures on a workbench or table which has a covered top. A piece of shallow nap rug or an old, coarse blanket is an ideal covering. Such a covering not only reduces the chances of the rifle slipping and being scratched, but it serves also to trap pins, plungers and springs that may otherwise get lost. It is advisable to have a container – such as a shoebox – in which each part can be placed as it is removed from the firearm.

Before attempting to disassemble the rifle for the first time, study the parts drawing and parts list to become familiar with the relative position, appearance and name of each part. Carry out the disassembly slowly and carefully. Note the position of the part in the firearm before starting to remove it. Taking photographs prior to disassembly may be helpful for reassembly. If a part is under spring tension (such as the hammer, tubular magazine components, and sear/trigger assembly) remove it cautiously and anticipate the direction the spring and/or components are most likely to “jump.”

If a spring or plunger becomes lost, do not use a substitute. Springs of correct tension are vital to the safe and reliable performance of firearms. Before starting disassembly, remove the sling, scope and rings and place the rear sight blade (if so equipped) in its down flat position.

CAUTION: Lever-action centerfire firearms should **NOT** be disassembled beyond what is described in this manual, except by the factory.

Unload the firearm before cleaning. Look into the ejection port and visually check the chamber and magazine to make sure there are no cartridges in the firearm. Always wear eye protection when handling, disassembling and assembling the firearm.

1. **Always keep the firearm pointed in a safe direction.**
2. Open the action by rotating the lever downward/forward until the bolt is fully rearward.
3. Engage the safety mechanism by moving the safety button fully to the shooter's right. The red band will not be visible.
4. Look into the ejection port, visually check the chamber, loading port and magazine for cartridges, ensuring the firearm is completely unloaded. If the firearm is not empty, see "To Unload Rifle," p. 26.
5. To remove the lever from the receiver, begin by rotating the lever half way through its stroke.
6. Remove the lever mounting screw by turning the screw counterclockwise. See Figure 14.
7. Pull the lever down and remove it from the bolt assembly and receiver. See Figure 15.

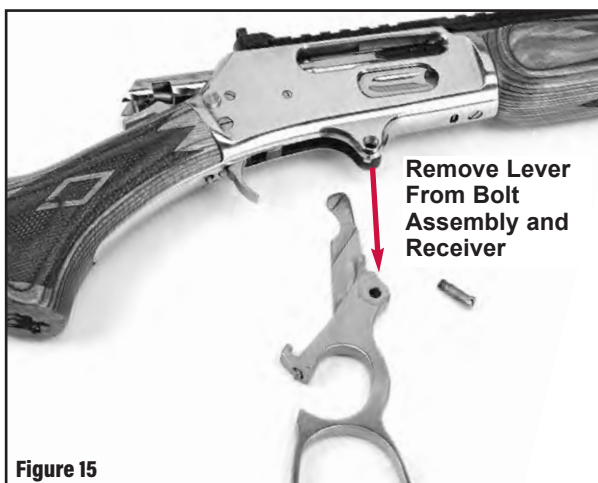
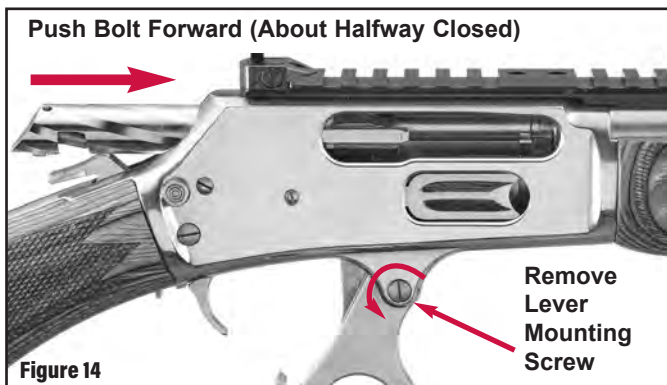

To Remove the Bolt Assembly:

8. With the lever removed, lay the receiver flat with the ejection port up to maintain the position of the ejector and pull the bolt assembly rearward from the receiver. See Figure 16.
9. With a pair of pliers, remove the ejector from the receiver by lifting it out through the ejection port. See Figure 17. **Be careful not to damage the ejector.**

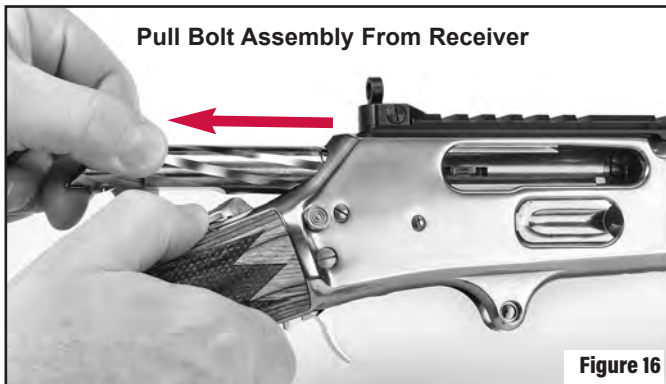

To Remove the Butt Stock:

10. Remove the butt stock mounting screw located on the tang behind the hammer (sometimes called the tang screw) by turning it counterclockwise. See Figure 18.
11. With a firm grip on the receiver and butt stock, pull the butt stock from the receiver. See Figure 19.

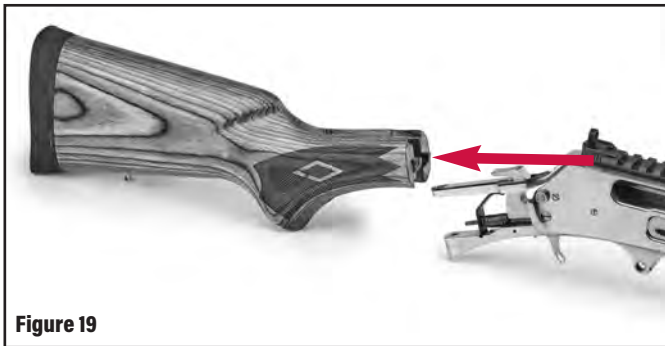
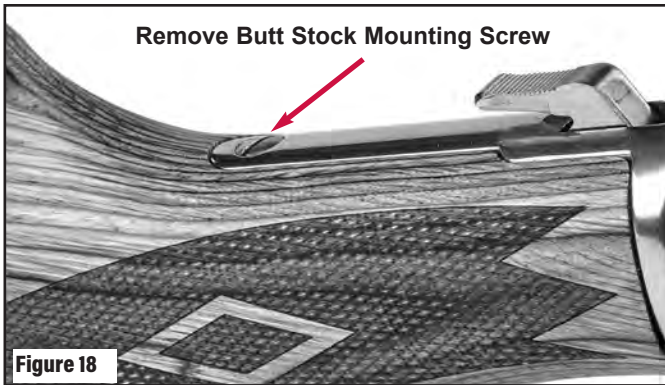

CARE AND CLEANING



WARNING: BEFORE CLEANING, BE CERTAIN THE RIFLE AND ITS MAGAZINE CONTAIN NO CARTRIDGES.

An on-line video demonstrating the care and cleaning of the Marlin® Model 1895 and 336 rifles can be viewed by going to MarlinFirearms.com/TechTips.

A firearm must be free of rust, dirt, grease and firing residues to function safely and reliably. Periodic maintenance, which includes inspection of components to determine if they are in proper working order, is absolutely essential. Firing the rifle deposits particles of bullet, lubricant and powder in the bore, chamber, bolt, receiver, magazine and other parts of the rifle. There is no fixed rule as to how frequently the cleaning should be carried out, but the alert firearm owner soon learns that any firearm functions most reliably and accurately when it is free of accumulations of grease and other firing residues.

Basic cleaning equipment includes: A correct size cleaning rod equipped with bore brushes (fiber and brass) and a tip in which a cloth patch can be inserted, patches, powder solvent, lubricant, small lint-free cloths and a toothbrush. Use correct size patches and brushes. Larger sizes will bind in the bore and can be very difficult to remove! Insert the cleaning rod from the chamber end of the barrel and push firmly so the patch or brush emerges from the muzzle. Don't reverse the rod when a brush or patch is being used before the brush or patch exits the muzzle – it may bind. Don't use patches or brushes dripping with solvent or oil. Use rod and brushes with care so as not to damage the firearm.

1. For routine cleaning, it is necessary only to remove the lever, bolt, and ejector.
2. Push-pull a properly sized, solvent-wetted patch through the bore several times. Next, using a solvent-wetted brush, run it the full length of the bore as many times as is necessary to completely dislodge all foreign matter from the bore and chamber. Dry the bore with clean patches and examine it. If the bore remains fouled, repeat the brushing. Complete the cleaning by dry-patch wiping the bore and chamber.
3. Use a clean, solvent-wetted patch to remove firing residue and dirt from all "reachable" surfaces inside the receiver. Use the solvent-wetted toothbrush to dislodge residue from all parts of the bolt assembly and from surfaces inside the receiver that can't be reached with a patch. Use cleaning patches or the cloth to remove the solvent.
4. Wipe all surfaces – internal and external – with a very light coat of oil. Oil and similar preparations "collect" dirt particles that can interfere with reliable functioning of the rifle. Therefore, use these preparations very sparingly. A drop of oil applied to the bolt assembly components, the pivot points of the trigger mechanism, and the safety, will work into all the parts that need lubrication.

5. Reassemble the rifle and carefully wipe off all excess solvent, lubricating and preservative preparations from the rifle.

NOTE: For rifles with wood or laminate stocks, use of cleaning solvents containing acetone can damage the finish of your stock.

6. If the rifle is to be stored for an extended period, clean the rifle thoroughly. Disassemble to the extent described elsewhere in this manual, taking care to put pins and similar easily mislaid and "rolling" components in a tray. Rewipe all surfaces with preservative oil. Reassemble and store properly.

 WARNING - LUBRICATION	
	<p>Firing a rifle with oil, grease, or any other material even partially obstructing the bore may result in damage to the rifle and serious injury to the shooter and those nearby. Do not spray or apply lubricants directly on ammunition. If the powder charge of a cartridge is affected by the lubricant, it may not be ignited, but the energy from the primer may be sufficient to push the bullet into the bore where it may become lodged. Firing a subsequent bullet onto the obstructed bore may damage the rifle and cause serious injury or death to the shooter and those nearby. Use lubricants properly. You are responsible for the proper care and maintenance of your firearm.</p>
IMPROPER LUBRICATION DESTROYS FIREARMS	

To Clean the Barrel:

1. Use the instructions and equipment provided in a quality cleaning kit. For recommendations, see your dealer.
2. Saturate a cleaning patch with a bore cleaner.
3. Attach the patch to a cleaning rod tip.
4. Pass the patch through the bore from the chamber end to the muzzle several times removing loose residue and fouling.
5. Select the correct caliber cleaning brush and attach a brush to the cleaning rod.
6. Spray the bore brush with a bore cleaner.
7. Push the cleaning rod through the barrel several times.
8. Remove the brush from the rod and attach a tip with a cleaning patch.
9. Push the cleaning patch through the bore.
10. Repeat several times using a new cleaning patch each time until the patch is removed from the barrel without fouling residue.
11. Push a clean patch saturated with a quality gun oil through the barrel.
12. Push a clean dry patch through the barrel to remove excess lubricant.
13. Apply a light application of quality gun oil to the outside of the barrel with a soft clean cloth.

After cleaning, Make sure the barrel is free of obstructions, see "To Check the Barrel for Obstructions," p. 28.

To Clean the Bolt Assembly:

1. Thoroughly spray and brush the bolt body using a quality gun cleaner.
2. Spray around the front and rear firing pins with a quality gun cleaner.
3. Air dry or use compressed air to thoroughly dry the bolt body and firing pins.
4. Apply a light application of gun oil to the inside and outside of the bolt assembly, the firing pins and the firing pin spring.
5. Ensure the firing pin spring is present and the rear firing pin moves freely by pushing on the rear firing pin.
6. If the rear firing pin does not move freely, repeat steps 1 through 5. See Figure 20.

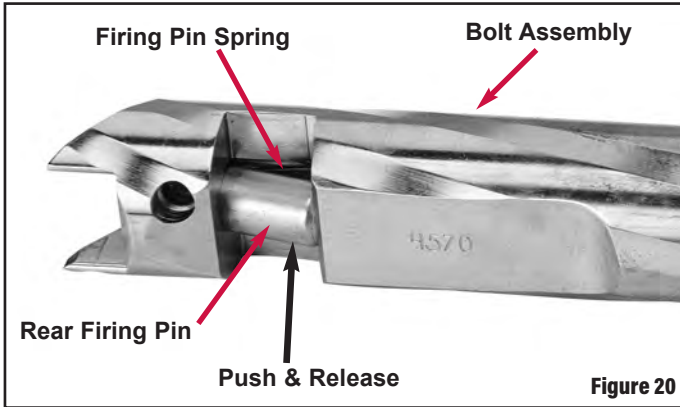

WARNING - REAR FIRING PIN

If the rear firing pin does not return fully downward after being depressed, then your firearm is **NOT** in a safe operating condition and it must **NOT** be used until you have it inspected and the problem corrected by the factory.

To Clean the Receiver and Ejector (See Figure 21.):

1. Thoroughly spray and then brush all components inside the receiver using a gun cleaner.
2. Thoroughly spray and, if required, brush the ejector using a gun cleaner.
3. Air dry or use compressed air to thoroughly dry the receiver assembly and the ejector.
4. Apply a light application of gun oil to the inside and outside of the receiver and the ejector.

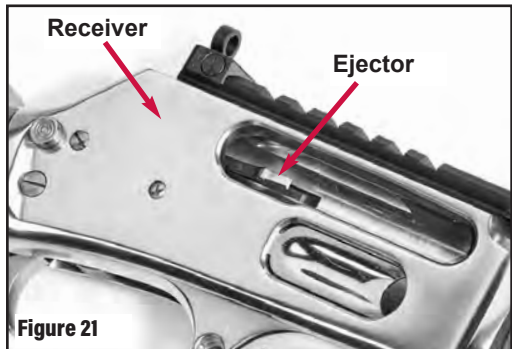

To Clean and Lubricate the Trigger & Hammer:

NOTE: Clean and lubricate the trigger and hammer assemblies as a unit. Do not remove the hammer or the trigger assembly from the receiver.

1. With the bolt removed and the hammer in the second stageable position (full cock), thoroughly spray inside the receiver with a gun cleaner. For better spray control use a spray straw.
2. Move the safety mechanism from the "SAFE" to "FIRE" position multiple times.
3. Air dry or use compressed air to thoroughly dry the receiver assembly.
4. Ensure the locking bolt moves freely by pushing the locking bolt from the bottom of the receiver. See Figure 22.

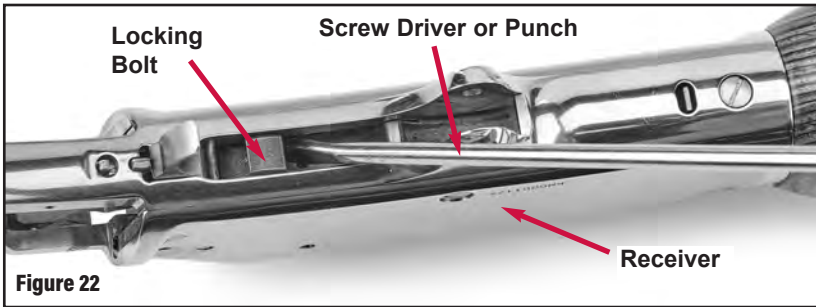

5. If the locking bolt does not move freely, repeat steps 1 through 4.
6. Lightly lubricate each of the four (4) points as shown in Figures 23 and 24, below.

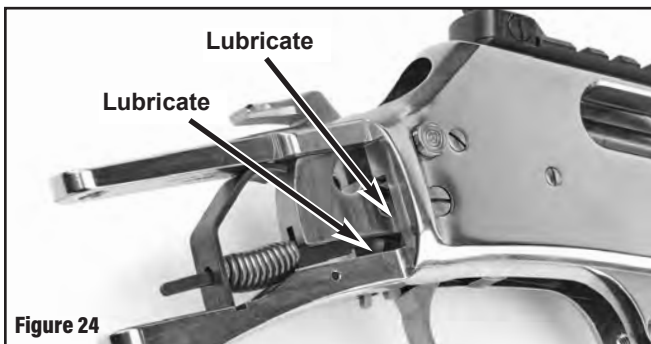
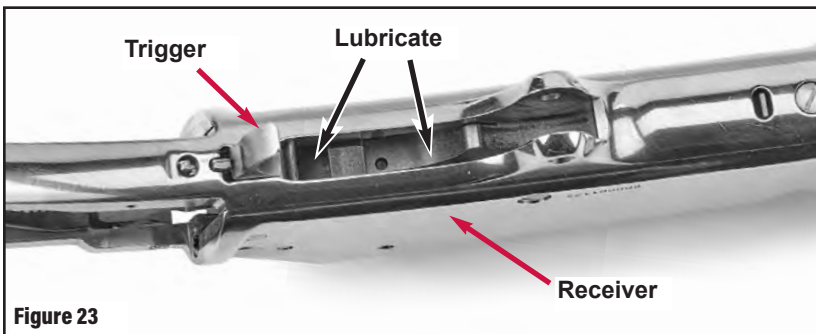

NOTE: While your lever-action firearm has been designed and manufactured to provide improved corrosion protection, only proper care will keep your firearm in good operating condition and maintain its appearance. After extensive use, the protective coating on plated parts may be worn sufficiently, reducing the corrosion protection.

Such worn parts should be replaced to assure the integrity of the corrosion protection.

MAINTENANCE OF STAINLESS STEEL RIFLES

Firearms and components made of stainless steel are relatively more resistant to corrosion than those of blued steel. However, in the interest of proper operation and long life of a stainless steel firearm, inspect it frequently and clean, lubricate and apply an appropriate rust preventative.

Sometimes discoloration occurs from perspiration or from contact with some types of firearm cases. Rusting may occur as a result of the firearm being exposed to moisture, salt air or chemicals.

Minor discoloration can usually be removed by rubbing the stainless area with an abrasive ink eraser, crocus cloth, or a "metal polishing" compound. When using any of these abrasives, proceed with care and use light pressure to achieve a blending of "color" with those areas that are not discolored.

External surfaces most subject to rusting from handling or from exposure to the elements should be cleaned and wiped dry after use or after exposure to adverse conditions. If the rifle is to be stored, coat it with a light film of oil or preservative. Where the rifle is in continuing use, and the presence of oil or grease would be objectionable, then the external surfaces can be coated (after cleaning and drying) with a paste wax formulated for use on metals. Apply the wax sparingly, allow time for it to dry hard, then buff lightly with a soft cloth. When applying the wax, take care that it does not get into the mechanism or on the functioning parts or in the bore.

REASSEMBLY

(Again, Be Sure Rifle Is Unloaded)

Always wear eye protection when handling, disassembling and assembling the firearm.

Before replacing the bolt assembly, make sure the barrel is free from obstructions and the chamber is empty. See "To Check for Barrel Obstructions," p. 28.

1. With the closed end of the ejector to the rear, insert the ejector into the ejector slot of the receiver.

Make sure that the ejector is oriented correctly so that: (1) the post rests in the hole at the rear end of the ejector slot; and (2) the flat spring rests in the slot and points toward the muzzle. See Figure 25.

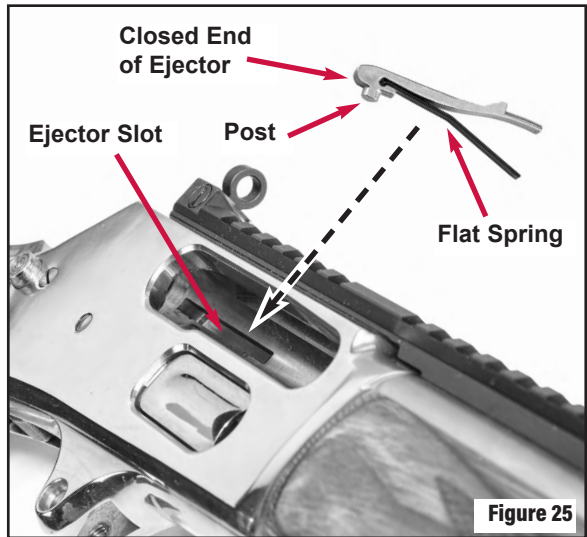

Figure 25

2. Ensure the locking bolt is in the down or unlocked position. If the locking bolt is in the up position, from the rear of the receiver push down on the locking bolt with a small screwdriver. See Figure 26.

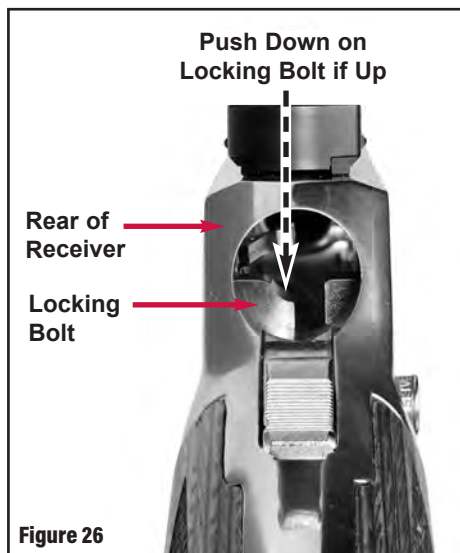
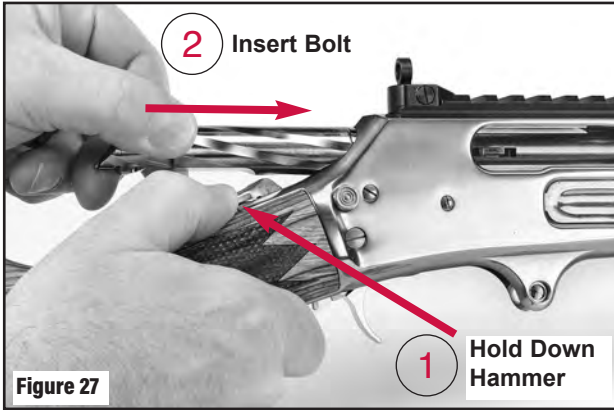

Figure 26

3. Hold the hammer down and insert the bolt assembly into the rear of the receiver. Orient the bolt with the extractor to the shooter's right. See Figure 27.
4. Make sure the rifle is laying flat and that the ejector remains in the ejector slot as the bolt is inserted.



5. Push the bolt forward approximately half way to the fully closed position (the bolt occupies half the ejector port).
6. From the bottom of the receiver, insert the lever through the lever slot in the bolt assembly until the lever mounting holes are aligned with the corresponding receiver mounting hole. See Figure 28



7. Attach the lever to the receiver by inserting and tightening the lever mounting screw from the shooter's right. Tighten the lever mounting screw hand tight. Do not over tighten. See Figure 29.



8. Insert the butt stock onto the rear of the receiver. See Figure 30.
9. Insert and tighten the butt stock mounting screw so that it is snug. Do not over tighten. See Figure 31.

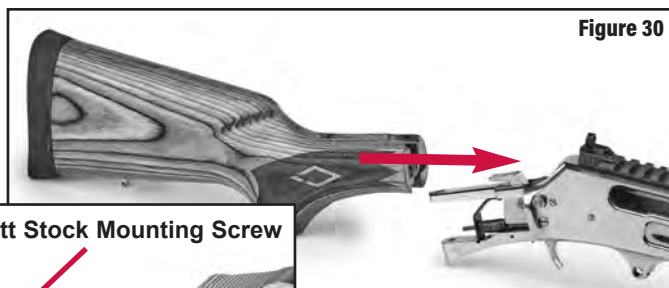

Figure 30

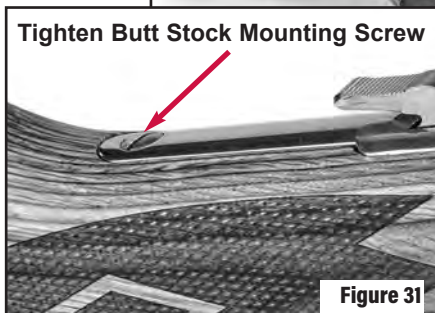

Figure 31

10. Tighten all receiver screws. There are three (3) screws on the shooter's right and one (1) screw on the shooter's left. Do not over tighten. See Figures 32 and 33. **Do not attempt to remove or loosen these screws.**

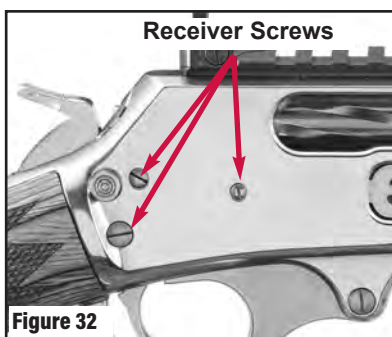

Figure 32

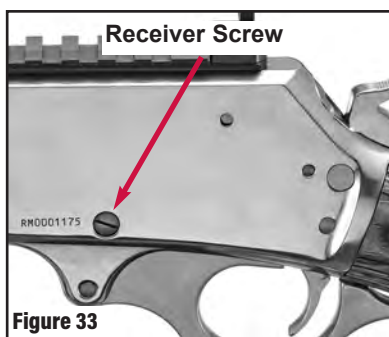

Figure 33

11. If a scope is mounted, ensure the scope is secure and the offset hammer spur is securely mounted. See "Offset Hammer Spur," p. 16.
12. Ensure the safety mechanism is engaged or in the "SAFE" position. The red band will not be visible.

CHECK YOUR RIFLE'S FUNCTION

Periodic inspection of any firearm is important to ensuring its safe operation. It is important to clean and inspect your firearm after each range session or whenever the firearm has been exposed to sand, dust, moisture, humidity, or other adverse conditions. Proper maintenance increases the longevity of your firearm and will allow early detection of worn or broken parts.

Prior to each use, visually inspect the firearm to ensure no components are damaged, missing, loose, bent, cracked, chipped, or peened. If you observe excessive wear, you should stop using your rifle and contact customer service or a trained certified gunsmith to evaluate its condition and replace any worn parts if necessary.

After any disassembly and reassembly, it is important to verify that the action is working correctly before any live firing is attempted.

Completely unload the firearm before function testing the firearm. Look into the ejection port and visually check the chamber, loading port, and magazine to make sure there are no cartridges in the firearm.

1. Open the action by rotating the lever downward/forward until the bolt is fully rearward.
2. Engage the safety mechanism by moving the safety button fully to the shooter's right. The red band will not be visible.
3. Ensure the rear firing pin is disconnected and the firing pin spring is present and pliable. Push on the rear firing pin from the bottom of the bolt, then release. The rear firing pin should return to the downward position without hesitation. See Figure 34.

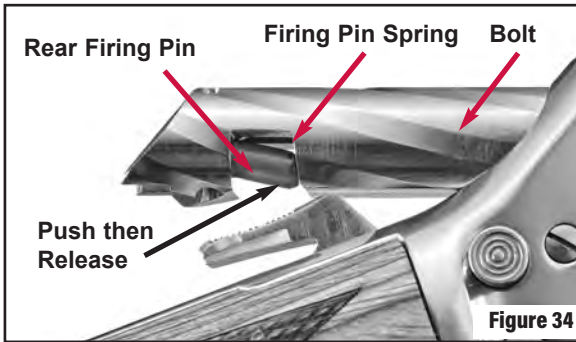



WARNING - REAR FIRING PIN

If the rear firing pin does not move freely or return to the downward position (disconnected) without hesitation when pushed and released, your firearm is not safe. The rifle should be returned directly to our Customer Service Department for inspection and repair, if required. See "Shipping Firearms For Repair" on p. 51 of this manual for packing and shipping information. The use of a firearm that is not in a safe operating condition may result in serious personal injury, and damage to property.

4. Look into the ejection port, ensure the firing pin tip is NOT protruding from the bolt face. Figure 35 shows the correct firing pin tip position (not protruding).

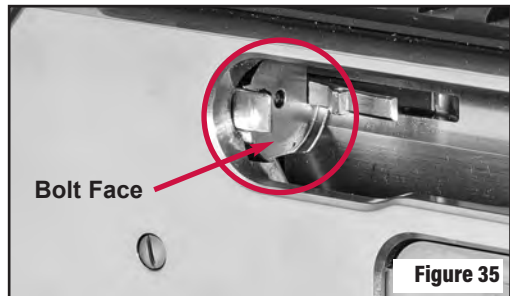

WARNING - PROTRUDING FIRING PIN

If the firing pin is protruding from the bolt face, your firearm is not safe. Contact Marlin® customer service to arrange for return and repair of the rifle. See "Shipping Firearms for Repairs," p. 51. The use of a firearm that is not in a safe operating condition may result in serious personal injury, injury to by-standers and/or death and damage to property.

5. With the safety mechanism engaged, cycle the action by rotating the lever downward/forward and then fully closing the lever by rotating it upward/rearward.
6. Disengage the safety. **With the rifle pointed in a safe direction**, pull the trigger fully rearward and then remove your finger from trigger. The hammer should release when the trigger is pulled.
7. Ensure the trigger returns completely to the forward position each time the trigger is pulled.
8. Cycle the action and repeat steps 5 through 7 multiple times.

If the trigger does not fully return to the forward position each time it is released, then your firearm is **NOT** in a safe operating condition and it must **NOT** be used until you have it inspected and the problem corrected by a factory technician.

9. With the safety mechanism engaged, move the lever fully downward/forward and then rotate the lever upward/rearward until it is between 1/8 and 1/4 inch from the fully upward/rearward or the closed position. See Figure 36.

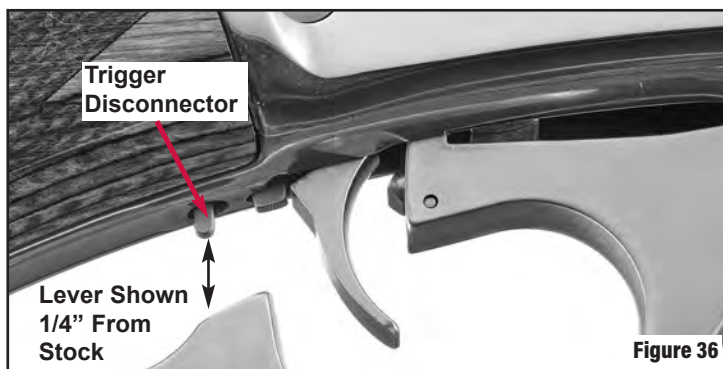

10. Pull the trigger. The hammer should Not release.
11. Repeat steps 9 and 10 multiple times.

If the hammer releases when the lever is not fully rotated upward/rearward, then your firearm is **NOT** in a safe operating condition and it must **NOT** be used until you have it inspected and the problem corrected by a factory technician. The use of a firearm that is not in a safe operating condition may result in serious personal injury, death and damage to property.

12. Cycle the action and fully rotate the lever upward/rearward into the closed position.
13. Ensure the lever remains in the fully upward/rearward or the closed position. When the lever is fully closed, there should not be a gap between the trigger disconnector and the lever. For the location of the trigger disconnector see Figure 36.

If the lever does not remain in the fully closed position, then your firearm is **NOT** in a safe operating condition and it must **NOT** be used until you have it inspected and the problem corrected by a factory technician. The use of a firearm that is not in a safe operating condition may result in serious personal injury, death and damage to property.

14. Fully cycle the action. Ensure the lever is rotated fully upward/rearward.
15. With the safety mechanism engaged, place your thumb on the hammer and apply enough thumb pressure to keep the hammer from moving when it is released.
16. While maintaining control of the hammer, pull the trigger until the trigger releases, allow the hammer to partially move forward, remove your finger from the trigger, and lower the hammer to the half cock position. See the "Half Cock" Figure 4b on p. 13.

17. Pull the trigger. The hammer should not release.

If the hammer releases when the hammer is in the "Half Cock" or first stageable position, then your firearm is **NOT** in a safe operating condition and it must **NOT** be used until you have it inspected and the problem corrected by a factory technician. The use of a firearm that is not in a safe operating condition may result in serious personal injury, death and damage to property.

18. Cycle the action and ensure the lever is fully upward/rearward or in the closed position.

19. With the hammer in the full cock position, operate the safety from the "FIRE" to the "SAFE" position multiple times. The safety mechanism must operate freely when the safety button is moved from the "SAFE" to "FIRE" position. It must NOT stop between the two positions.

20. Repeat steps 15 through 17 multiple times.

If the safety does **NOT** freely return to the full "Safe" or full "Fire" position after repeating steps 19 thru 21 multiple times, then your firearm is **NOT** in a safe operating condition and it must **NOT** be used until you have had it inspected and corrected by a factory technician. The use of a firearm that is not in a safe operating condition may result in serious personal injury, death and damage to property.

21. Ensure the safety mechanism is engaged by moving the safety button fully to the shooter's right.

22. With the safety mechanism engaged, lower the hammer to the "Half Cock" or first stageable position. See "Getting Ready to Shoot," p. 20.

Incorrectly assembling the firearm or the use of modified parts can result in damage to your firearm and personal injury or death to you or others. The Marlin® Model 1895 rifle should be returned directly to our Customer Service Department for inspection and repair, if required. See "Shipping Firearms For Repair" on p. 51 of this manual for packing and shipping information.

The firearm owner and user must accept full responsibility for the correct reassembly and functioning of the firearm after disassembly or replacement of parts.

If any of the above function checks fail or if you are uncertain, please consult a competent gunsmith or contact Marlin® Customer Service at 336-949-5200 for further firearm inspection before using the rifle.

SIGHT ADJUSTMENT

Before adjusting the sights or mounting any optic sights, make sure the firearm is completely unloaded and the safety mechanism is engaged by placing the safety in the "ON" or "SAFE" position.

Rear Sight Adjustment For Marlin® Rifles Equipped With Semi-Buckhorn Sight:

The rear sight is adjustable for both windage and elevation. Move the rear sight aperture in the direction you wish to move the bullet's point of impact on the target.

Rear Sight Elevation Adjustment (See Figure 37):

To move the point of impact up, move the elevator blade higher.

To move point of impact down, move the elevator blade to a lower notch.

Rear Sight Windage Adjustment (See Figure 37):

To move the point of impact right, tap the sight base to the right.

To move the point of impact left, tap the sight base to the left.

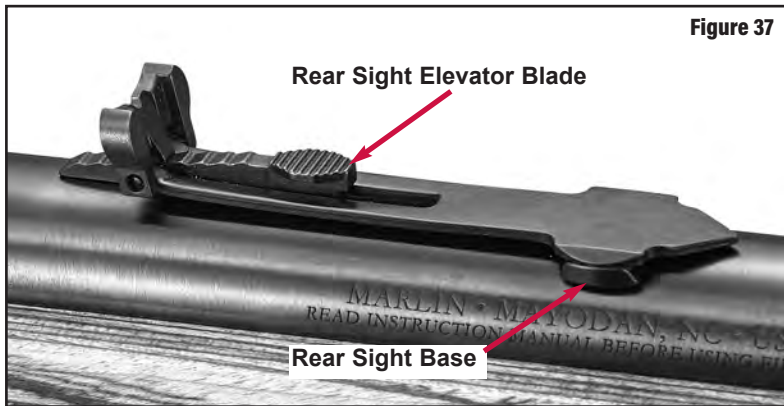

Sight Adjustment For Marlin® Rifles Equipped With a Rail and Ghost Ring:

Some Marlin® rifles are equipped with a rail and ghost ring. The rear sight is adjustable for both windage and elevation. Move the rear sight aperture in the direction you wish to move the bullet's point of impact on the target.

Rear Sight Elevation Adjustment (See Figure 38):

To move the point of impact up, use a .050 hex wrench to loosen (but do not remove) the set screw on the left side of the rear sight. Loosening this set screw allows the rear sight aperture to be turned. Turn the aperture counter-clockwise to raise the aperture. One half of a turn (180 degrees) will shift the point of impact .68" up at 50 yards. Tighten the set screw.

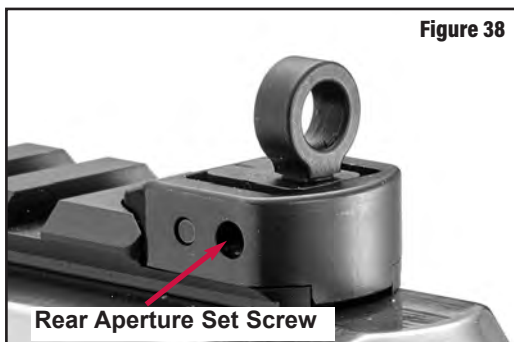

To move point of impact down, use a .050 hex wrench to loosen (but do not remove) the set screw on the left side of the rear sight. Loosening this set screw allows the rear sight aperture to be turned. Turn the aperture clockwise to lower the aperture. One half of a turn (180 degrees) will shift the point of impact .68" down at 50 yards. Tighten the set screw.

Rear Sight Windage Adjustment (See Figure 39):

To move the point of impact right, use a flat head screw driver to turn the screw on the right side of the sight clockwise. One click equals .18" at 50 yards.

To move the point of impact left, use a flat head screw driver to turn the screw on the right side of the sight counter-clockwise. One click equals .18" at 50 yards.





WARNING - TRITIUM SIGHT

Tritium is non-hazardous so long as the tritium vials are unbroken. No attempt should be made to disassemble the sights or otherwise break the vial containing tritium. If you come into contact with a broken or leaking tritium vial, you should wash your hands carefully with soap and water and avoid ingesting or inhaling the gases. Additionally, great care should be taken to avoid flame in the presence of a broken or leaking tritium vial and you should not handle the damaged sights if you have open cuts or abrasions. Only handle sights with damaged or leaking tritium sights in a well ventilated area and avoid inhaling air near the damaged vial.

BE CAREFUL WITH TRITIUM VIAL!

THREADED BARREL (ON MODELS SO EQUIPPED)

If your Marlin® rifle comes equipped with a threaded barrel, it will include a removable muzzle cap. The cap protects the threads at the end of the barrel, which is designed to accommodate a sound suppressor or other muzzle device. (See Figure 38.) The Marlin® Model 1895™ chambered in 45-70 Gov't utilizes 11/16" x 24 threads. The Marlin® Model 336™ chambered in 30-30 Win utilizes 5/8" x 24 threads.



WARNING - MUZZLE DEVICES

Ensure that all muzzle devices installed on the rifle are intended for use on firearms chambered in the caliber marked on the barrel. Failure to do so may result in injury and damage to your rifle.

USE MUZZLE DEVICES OF THE CORRECT CALIBER

STORAGE

FIREARMS SHOULD NOT BE STORED LOADED!

**USE THE LOCKING DEVICE SUPPLIED WITH THE RIFLE TO
RENDER IT INOPERATIVE FOR SAFE STORAGE.**

(SEE PAGE 9)

Do not store the rifle in a leather case or scabbard. Leather attracts moisture, even though it may appear to be dry.



WARNING - STORAGE



- Never place or store any firearm in such a manner that it may be dislodged. Firearms should always be stored securely and unloaded, away from children and careless adults.
- Use the locking device supplied with the rifle for storage. The use of a locking device is only one aspect of responsible firearms storage.
- For increased safety, firearms should be stored unloaded in a location that is both separate from their ammunition and inaccessible to children and any other unauthorized person.

STORE SECURELY & UNLOADED

SERVICE AND PARTS POLICY

NOTE: RUGER® CAN ONLY SERVICE MARLIN® FIREARMS MANUFACTURED BY RUGER®. THESE FIREARMS CAN BE IDENTIFIED BY THE LOCATION OF MANUFACTURE - "MAYODAN, NC" ON THE BARREL. SEE P. 8. PLEASE DO NOT SEND OLDER MARLIN® FIREARMS TO RUGER CUSTOMER SERVICE - THEY WILL BE RETURNED TO YOU.

If you have any question regarding the performance of your Marlin® rifle please contact our Customer Service online at MarlinFirearms.com or call the Customer Service Dept. at 336-949-5200. Fully describe all circumstances and conditions involved. If you should need to return your rifle to the factory for repair, or order parts for it, please comply with the following suggestions for prompt service:



WARNING: BEFORE SHIPPING ANY FIREARM, BE ABSOLUTELY CERTAIN THAT IT IS UNLOADED. DO NOT SHIP CARTRIDGES WITH A FIREARM.

SHIPPING FIREARMS FOR REPAIR

NOTE: You must obtain a Repair Authorization Number before returning your firearm. An authorization number can be obtained by contacting Customer Service online at **MarlinFirearms.com** or calling the Customer Service Department at 336-949-5200. Firearms should be sent prepaid. We will not accept collect shipments. Any Marlin® rifle returned to the factory for repair should be sent to: Sturm, Ruger & Company, Inc., Customer Service Department, 271 Cardwell Rd., Mayodan, NC 27027.

The Federal Gun Control Act, as well as the laws of most states and localities, do not prohibit an individual (who is not otherwise barred from purchasing or possessing a firearm) from shipping a firearm directly to the manufacturer for repair. However, before you ship your firearm to us, be certain that your state or locality does not have a law or regulation which will prohibit you from receiving the firearm (or any included magazines) from us after repair. If such receipt is prohibited, please have a federally licensed firearms dealer ship the firearm to us. If your firearm is sent to us by a dealer, it will be returned to that dealer after being repaired. If a handgun (pistol or revolver) is shipped by an individual who does not hold a Federal Firearms License, it must be shipped for overnight delivery via U.P.S., Federal Express or other, similar private overnight service. **NOTE:** Persons who do not hold a Federal Firearms License are prohibited by Federal law from shipping a handgun by U.S. Mail. Handguns mailed in violation of the law may be impounded or confiscated by the Post Office and the non-FFL may be subject to prosecution. Rifles and shotguns may be shipped via U.S. Mail.

Please do not include rifle case, sling, telescopic sights or custom accessories with a firearm being shipped to the factory for service. **DO NOT SEND FIREARM BOXES OR LITERATURE THAT YOU CONSIDER TO BE COLLECTOR'S ITEMS - THESE ARE INVARIABLY DAMAGED OR DESTROYED IN SHIPMENT.** Always insure your shipment.

Enclose a letter which includes your name, address, telephone number, firearm serial number and model, and repair authorization number. Describe in detail the trouble you have experienced with your firearm, or the work you wish to have done. Merely stating that the firearm "needs repair" is inadequate information. Please enclose copies of any previous correspondence.

All work performed is subject to a minimum labor charge and charges for shipping and handling. Most models can be reblued, but custom gunsmithing service or nonstandard alterations are NOT AVAILABLE from Marlin Customer Service Departments. Please contact the Customer Service Department for pricing information.



WARNING - PARTS PURCHASERS



- It is the purchaser's responsibility to be absolutely certain that any parts ordered from the factory are correctly fitted and installed.
- Firearms are complicated mechanisms and **IMPROPER FITTING OF PARTS MAY RESULT IN A DANGEROUS MALFUNCTION, DAMAGE TO THE FIREARM, AND SERIOUS INJURY TO THE SHOOTER AND OTHER PERSONS.**
- The purchaser and installer of parts must accept full responsibility for the correct adjustment and functioning of the firearm after such installation.

PARTS MUST FIT CORRECTLY

ORDERING PARTS

Please contact the Mayodan, North Carolina Customer Service Department for parts availability and current prices. All parts orders for Marlin® rifles should be sent to: Sturm, Ruger & Company, Inc., Customer Service Department, 271 Cardwell Rd., Mayodan, NC 27027, 336-949-5200.

We cannot comply with open account or C.O.D. requests. Payment in full via credit card (Visa or MasterCard only), money order or certified bank check (no personal checks or cash, please) is required before any service will be performed. Please provide your credit card number, your name as it appears on the credit card, the expiration date, and the 3-digit security code. All parts orders are subject to a minimum charge and charges for shipping and handling. Order parts by **Part Name and specify the model and entire serial number** of the firearm for which the parts are being ordered. There is a minimum labor charge plus a shipping and handling charge if the parts are factory fit. All factory fit parts are fit on an exchange basis only. We will not return the replaced parts. Please contact the Customer Service Department for pricing information.

Because the receiver of the Marlin® rifle is a serial numbered component, it is defined as a "firearm" by Federal law and is not sold as a separate component.

*Parts designated by an asterisk must be factory fit. These parts are fit on an exchange basis only. We will not return the replaced parts. We will not return any part that is broken, malfunctioning, badly worn or has been modified. See "Warning — Parts Purchasers," above.



WARNING: A firearm containing broken, malfunctioning, or badly worn parts should not be fired.

MARLIN® MODEL 1895 and 336 RIFLES

PARTS LIST

Design, prices and specifications subject to change without notice.

SPECIFY MODEL, CALIBER AND SERIAL NO. WHEN ORDERING

(See Exploded View Page 54)

Key	Part Name	Key	Part Name
†	1 Receiver	32	Hammer Strut Pin
*	2 Trigger Guard Plate	33	Trigger Pin
*	3 Barrel	34	Trigger Spring Pin
*	4 Breech Bolt Assembly	35	Trigger Guard Plate Latch Pin
	5 Buttstock Assembly	36	Hammer Spur
	6 Magazine Tube Plug	37	Hammer Spur Screw
	7 Finger Lever Assembly	38	Magazine Tube
*	8 Hammer	39	Forearm
	9 Marlin Trigger	40	Forearm Tip Assembly
*	10 Sear	41	Forearm Tip Tenon
	11 Trigger Safety Blocker	42	Forend Tip Tenon Screw
	12 Trigger Spring	** 43	Thread Protector
	13 Hammer Strut	44	Magazine Tube Stud
	14 Hammer Adjusting Plate	45	Magazine Tube Stud Screw
	15 Hammer Spring	46	Loading Gate
	16 Magazine Tube Spring	47	Scope Rail (on some models)
	17 Follower	48	Rear Sight
	18 Lever Screw	49	Front Sight
	19 Trigger Guard Plate Screw	50	Front Sight Screw, # 6-48, Torx
	20 Hammer Screw	51	Rear Sight Screw, # 8-40, Torx
	21 Carrier Screw	52	Scope Rail Screw, # 8-40, Torx
	22 Trigger Guard Plate Support Screw	Front & Rear Sight Assemblies - Includes Key Nos. 53 - 60	
	23 Tang Screw	53	Front Sight Base
	24 Loading Gate Screw	54	Front Sight Screw, 2 Req'd
*	25 Locking Bolt	55	Front Sight
*	26 Safety Button	56	Front Sight Hood
*	27 Safety Detent Screw	57	Rear Sight Base Slide
*	28 Safety Detent Ball	58	Rear Sight Base
*	29 Safety Detent Spring	59	Rear Sight Folding Leaf
	30 Ejector Assembly	60	Rear Sight Elevator
	31 Carrier Assembly		

† The receiver is a serial-numbered part and is not offered for sale.

* Parts so marked must be factory fit.

** **NOTE:** This part is match sanded/polished with a mating part and a replacement may not be an exact finish match.

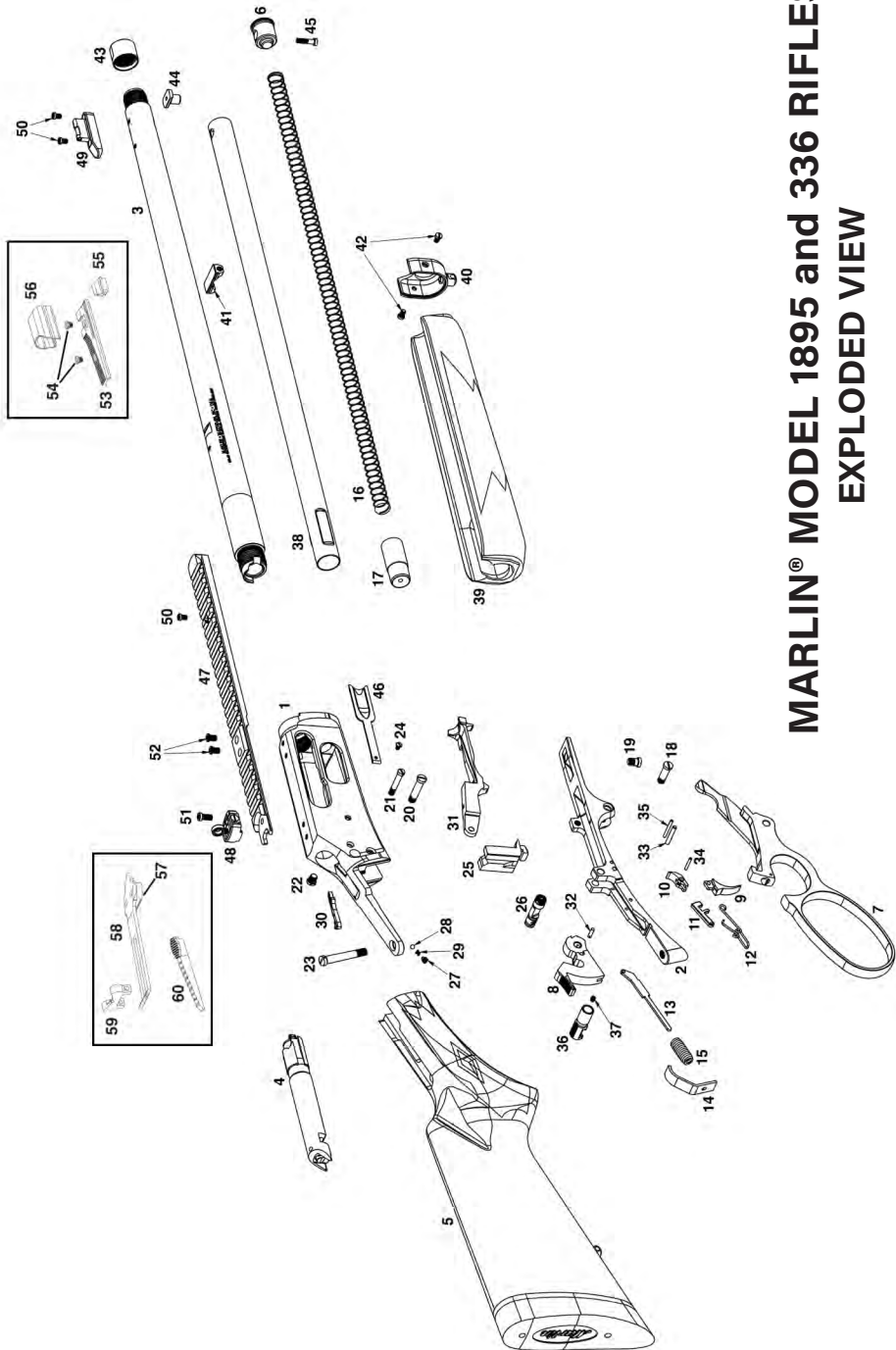

MARLIN® MODEL 1895 and 336 RIFLES EXPLODED VIEW

THE BASIC RULES OF SAFE FIREARMS HANDLING

We believe that Americans have a right to purchase and use firearms for lawful purposes. The private ownership of firearms in America is traditional, but that ownership imposes the responsibility on the gun owner to use his firearms in a way which will ensure his own safety and that of others. When firearms are used in a safe and responsible manner, they are a great source of pleasure and satisfaction, and represent a fundamental part of our personal liberty.

Firearms do not cause accidents! Firearms accidents are almost always found to have been the result of carelessness or ignorance on the part of the shooter of the basic rules of safe gun handling.

The following rules must be observed by gun users at all times. Safe gun handling is not just desirable, it is absolutely essential to your safety, the safety of others, and the continuation of gun ownership and sport shooting as we know it today.

1. LEARN THE MECHANICAL AND HANDLING CHARACTERISTICS OF THE FIREARM YOU ARE USING.

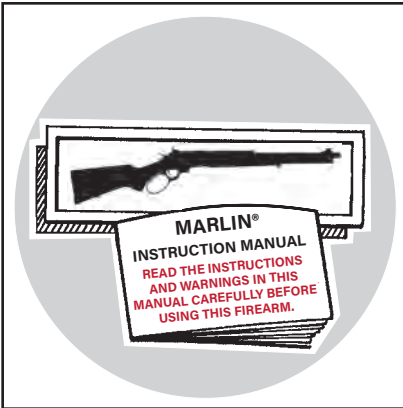

Not all firearms are the same. The method of carrying and handling firearms varies in accordance with the mechanical provisions for avoiding accidental discharge and the various proper procedures for loading and unloading. No person should handle any firearm without first having thoroughly familiarized himself with the particular type of firearm he is using, and with safe gun handling in general.

2. ALWAYS KEEP THE MUZZLE POINTED IN A SAFE DIRECTION.



Be sure of the bullet stop behind your target, even when dry-firing. Never let the muzzle of a firearm point at any part of your body or at another person. This is particularly important when loading or unloading a firearm. In the event of an accidental discharge, no injury can occur as long as the muzzle is pointing in a safe direction. A safe direction means a direction that will not permit a discharged bullet to strike a person, or

to strike an object from which the bullet may ricochet.

A safe direction must take into account the fact that a bullet may penetrate a wall, ceiling, floor, window, etc., and strike a person or damage property. Make it a habit to know exactly where the muzzle of your gun is pointing whenever you handle it, and be sure that you are always in control of the direction in which the muzzle is pointing, even if you fall or stumble. Keep your finger off the trigger until you are ready to shoot.

3. FIREARMS SHOULD BE UNLOADED WHEN NOT IN USE.

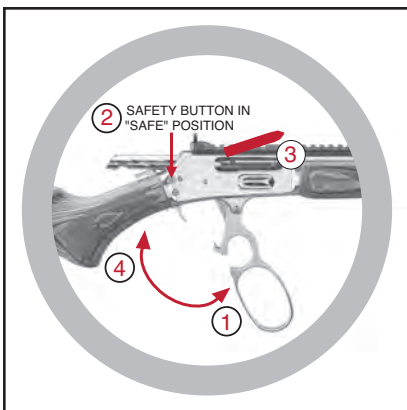

Firearms should be loaded only when you are in the field or on the target range or shooting area, ready to shoot. Firearms and ammunition should be securely locked in safes, racks or cabinets, or by using the locking device supplied with the firearm, when not in use. Ammunition should safely be stored separate from firearms. Store your firearms out of sight of visitors and children. It is the gun

owner's responsibility to be certain that children and persons unfamiliar with firearms cannot gain access to firearms, ammunition, or components.

4. BE SURE THE BARREL IS CLEAR OF OBSTRUCTIONS BEFORE SHOOTING.

Even a bit of mud, snow or excess lubricating oil or grease in the bore may cause the barrel to bulge, or even burst on firing, and can cause serious injury to the shooter and bystanders. Be sure that you are using ammunition of the proper caliber and loading for the gun you are using. If the report or recoil on firing seems weak, or doesn't seem quite right, CEASE FIRING IMMEDIATELY, unload your firearm, and check to be sure that no obstruction has become lodged in the barrel. Never try to shoot out an obstruction!

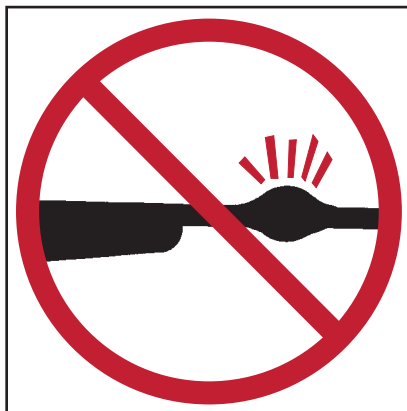



5. BE SURE OF YOUR TARGET BEFORE YOU SHOOT.

Don't shoot unless you know exactly where your bullet is going to strike. Be sure of the bullet stop behind your target, even when dry-firing with an unloaded gun. If you are in the field hunting, do not fire at a movement or noise. Take the time to be absolutely certain of your target before you pull the trigger.

6. WEAR SHOOTING GLASSES AND HEARING PROTECTION WHEN YOU SHOOT.

All shooters should wear protective shooting glasses and adequate hearing protection when shooting. Exposure to shooting noise can damage hearing, and wearing adequate eye protection when shooting is essential.

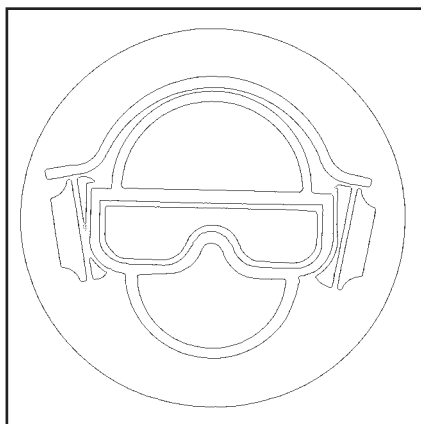

7. NEVER CLIMB A TREE OR FENCE WITH A LOADED FIREARM.

Put the firearm down carefully before climbing a fence, and unload it before climbing or descending a tree or jumping over a ditch or other obstruction. Never pull or push a loaded firearm toward yourself or another person. When in doubt, or whenever you are about to do anything awkward, unload your gun!

8. DON'T SHOOT AT A HARD SURFACE OR AT WATER.

Bullets can glance off many surfaces like rocks or the surface of water and travel in unpredictable directions with considerable velocity.



9. NEVER TRANSPORT A LOADED FIREARM.

Firearms should always be unloaded before being placed in a vehicle. A suitable carrying case or scabbard should be used to carry an unloaded firearm to and from the shooting area.

10. AVOID ALCOHOLIC BEVERAGES WHEN SHOOTING.

Don't drink until the day's shooting is over. Handling firearms while under the influence of alcohol in any form, or medications that could affect your judgment or coordination, constitutes a criminal disregard for the safety of others.



A BRIEF HISTORY of MARLIN® FIREARMS

The story of the Marlin Firearms Company is one of a distinctly American company. The company was started by John Mahlon Marlin, a gun builder at the Colt plant in Hartford, CT. He struck out on his own in 1870 and started building single-shot, brass framed derringers in .22 rimfire. He eventually added .32 and .38 calibers. Marlin's first rifle was a single-shot Ballard rifle.

In 1881, John Marlin made the company's first repeating lever-action rifle. The Model 1881 was a side-loading, top-eject rifle chambered for big bore cartridges like the .45-70 Gov't and 38-55.

It was 1889 though when Marlin produced the rifle that began the legacy that is alive and well today. The Model 1889 was the first lever rifle to side-load and side-eject, leaving a solid top. It was chambered for the caliber .32, .38 and .44 cartridges.

The solid top provided for a stronger receiver and ejected hot brass away from, instead of back toward, the shooter. This was the origin of the term "Marlin Safety" which was actually stamped into the top of the receiver. In later years, the solid top became popular for those shooters wanting to use optics but this was not the original intent.

The Model 1893 incorporated the locking block and a two-piece firing pin which is now featured in all current models.

WWI brought a lot of expansion – both in military firearms and in non-firearms related products like reloading equipment, razor blades, handcuffs, etc. Marlin was one of the world's largest machine gun manufacturers with the Browning 1895 and the Model 1917. But the end of the war brought devastating financial problems that resulted in bankruptcy and foreclosure in 1923. The company was auctioned off. The auction was reportedly attended by "several curious children, a small dog and a lawyer named Frank Kenna." Kenna bought Marlin for \$100 and assumption of the \$100,000 of debt the company had accumulated.

Throughout its tumultuous history, Marlin has made firearms of all shapes and sizes. Pistols, shotguns, rifles (bolt action, semi-auto, lever and pump), military firearms and dozens of non-firearm related items.

The Kenna family owned and managed the company for over 75 years until it was purchased by a holding company managed by Cerberus Capital Management, which also owned Remington Arms Company.

Remington Arms (and Marlin) struggled through a financial reorganization in 2018 and ultimately the companies were sold at auction in September 2020. Marlin® Firearms and all of its assets were purchased by Ruger® Firearms.

Instruction manuals for all Marlin® firearms,
can be downloaded from our website at:

marlinfirearms.com

WHY NO WARRANTY CARD HAS BEEN PACKED WITH THIS NEW MARLIN® FIREARM

The Magnuson-Moss Act (Public Law 93-637) does not require any seller or manufacturer of a consumer product to give a written warranty. It does provide that if a written warranty is given, it must be designated as "limited" or as "full" and sets minimum standards for a "full" warranty. Sturm, Ruger & Company, Inc. has elected not to provide any written warranty, either "limited" or "full", rather than to attempt to comply with the provisions of the Magnuson-Moss Act and the regulations issued thereunder. There are certain implied warranties under state law with respect to sales of consumer goods. As the extent and interpretation of these implied warranties varies from state to state, you should refer to your state statutes. Sturm, Ruger & Company wishes to assure its customers of its continued interest in providing service to owners of Marlin® firearms.



MARLINFIREARMS.COM

MARLIN® FIREARMS

271 Cardwell Road

Mayodan, North Carolina 27027 U.S.A.

Long Live the Lever Gun™

A copy of the instruction manual for your Ruger-made Marlin® firearm is available from the factory free on request, or it may be downloaded from our website at marlinfirearms.com. This instruction manual contains important warnings which must be understood before use.

The Following are Registered U.S. Trademarks Belonging to Sturm, Ruger & Co., Inc.: "RUGER," "Marlin," "Marlin, Horse & Rider (stacked)," "Marlin, Horse & Rider (linear)," "Horse & Rider," and "Micro-Groove"

The Following are Marlin Trademarks Belonging to Sturm, Ruger & Co., Inc.: "Model 1897," "Model 39," "Model 39A," "Model 1894," "Model 1895," "Model 336," "Model 444," "Model 60," "Model XT-17," "Model XT-22," "Long Live the Lever Gun," "Marlin Custom," "Marlin Custom Shop," "Dark Series," "Cowboy," and "Glenfield"